









# ZP3 系列

# 连接器 适合吸盘 一览

## ZP3 系列 安装用连接器型号

连接器型号		适合吸盘型号 ZP3系列	页码
ZP3A-T1-A3		ZP3-015U□ ZP3-02U□ ZP3-035U□	P.1168
ZP3A-T1-B3		ZP3-015U□ ZP3-02U□ ZP3-035U□	P.1168
ZP3A-T1-A6-B3		ZP3-015U□ ZP3-02U□ ZP3-035U□	P.1168
ZP3A-T2-A5		ZP3-04UM□ ZP3-06UM□ ZP3-08UM□ ZP3-04B□ ZP3-06B□ ZP3-08B□	P.1168
ZP3A-T2-B5		ZP3-04UM□ ZP3-06UM□ ZP3-08UM□ ZP3-04B□ ZP3-06B□ ZP3-08B□	P.1168
ZP3A-T2-A10-B5		ZP3-04UM□ ZP3-06UM□ ZP3-08UM□ ZP3-04B□ ZP3-06B□ ZP3-08B□	P.1168
ZP3A-T2-A10-04		ZP3-04UM□ ZP3-06UM□ ZP3-08UM□ ZP3-04B□ ZP3-06B□ ZP3-08B□	P.1168
ZP3A-T3-A5		ZP3-10UM□ ZP3-13UM□ ZP3-16UM□ ZP3-10B□ ZP3-13B□ ZP3-16B□	P.1168
ZP3A-T3-B5		ZP3-10UM□ ZP3-13UM□ ZP3-16UM□ ZP3-10B□ ZP3-13B□ ZP3-16B□	P.1169

连接器型号		适合吸盘型号 ZP3系列	页码
ZP3A-T3-A12-B5		ZP3-10UM□ ZP3-13UM□ ZP3-16UM□ ZP3-10B□ ZP3-13B□ ZP3-16B□	P.1169
ZP3A-T3-A12-04		ZP3-10UM□ ZP3-13UM□ ZP3-16UM□ ZP3-10B□ ZP3-13B□ ZP3-16B□	P.1169
ZP3A-T3-A12-06		ZP3-10UM□ ZP3-13UM□ ZP3-16UM□ ZP3-10B□ ZP3-13B□ ZP3-16B□	P.1169
ZP3A-Y1-B3		ZP3-015U□ ZP3-02U□ ZP3-035U□	P.1169
ZP3A-Y2-B5		ZP3-04UM□ ZP3-06UM□ ZP3-08UM□ ZP3-04B□ ZP3-06B□ ZP3-08B□	P.1169
ZP3A-Y3-B5		ZP3-10UM□ ZP3-13UM□ ZP3-16UM□ ZP3-10B□ ZP3-13B□ ZP3-16B□	P.1169

ZP3

ZP2

ZP2V

ZP

ZPT



ZPR



XT661

# ZP3 系列



## 缓冲器 适合吸盘 一览



缓冲器组件型号

缓冲器组件型号		适合吸盘型号	页码
		ZP3系列	
ZP3B-T1J3-B3		ZP3-015U <input type="checkbox"/> ZP3-02U <input type="checkbox"/> ZP3-035U <input type="checkbox"/>	P.1170
ZP3B-T1J6-B3		ZP3-015U <input type="checkbox"/> ZP3-02U <input type="checkbox"/> ZP3-035U <input type="checkbox"/>	P.1170
ZP3B-T1K3-B3		ZP3-015U <input type="checkbox"/> ZP3-02U <input type="checkbox"/> ZP3-035U <input type="checkbox"/>	P.1170
ZP3B-T1K6-B3		ZP3-015U <input type="checkbox"/> ZP3-02U <input type="checkbox"/> ZP3-035U <input type="checkbox"/>	P.1170
ZP3B-T2AJ3-B5		ZP3-04UM <input type="checkbox"/> ZP3-06UM <input type="checkbox"/> ZP3-08UM <input type="checkbox"/> ZP3-04B <input type="checkbox"/> ZP3-06B <input type="checkbox"/> ZP3-08B <input type="checkbox"/>	P.1170
ZP3B-T2AJ6-B5		ZP3-04UM <input type="checkbox"/> ZP3-06UM <input type="checkbox"/> ZP3-08UM <input type="checkbox"/> ZP3-04B <input type="checkbox"/> ZP3-06B <input type="checkbox"/> ZP3-08B <input type="checkbox"/>	P.1170
ZP3B-T2AJ10-B5		ZP3-04UM <input type="checkbox"/> ZP3-06UM <input type="checkbox"/> ZP3-08UM <input type="checkbox"/> ZP3-04B <input type="checkbox"/> ZP3-06B <input type="checkbox"/> ZP3-08B <input type="checkbox"/>	P.1170

缓冲器组件型号		适合吸盘型号	页码
		ZP3系列	
ZP3B-T2AK3-B5		ZP3-04UM <input type="checkbox"/> ZP3-06UM <input type="checkbox"/> ZP3-08UM <input type="checkbox"/> ZP3-04B <input type="checkbox"/> ZP3-06B <input type="checkbox"/> ZP3-08B <input type="checkbox"/>	P.1170
ZP3B-T2AK6-B5		ZP3-04UM <input type="checkbox"/> ZP3-06UM <input type="checkbox"/> ZP3-08UM <input type="checkbox"/> ZP3-04B <input type="checkbox"/> ZP3-06B <input type="checkbox"/> ZP3-08B <input type="checkbox"/>	P.1170
ZP3B-T2AK10-B5		ZP3-04UM <input type="checkbox"/> ZP3-06UM <input type="checkbox"/> ZP3-08UM <input type="checkbox"/> ZP3-04B <input type="checkbox"/> ZP3-06B <input type="checkbox"/> ZP3-08B <input type="checkbox"/>	P.1170
ZP3B-T2AJB15-B5		ZP3-04UM <input type="checkbox"/> ZP3-06UM <input type="checkbox"/> ZP3-08UM <input type="checkbox"/> ZP3-04B <input type="checkbox"/> ZP3-06B <input type="checkbox"/> ZP3-08B <input type="checkbox"/>	P.1170
ZP3B-T2AJB20-B5		ZP3-04UM <input type="checkbox"/> ZP3-06UM <input type="checkbox"/> ZP3-08UM <input type="checkbox"/> ZP3-04B <input type="checkbox"/> ZP3-06B <input type="checkbox"/> ZP3-08B <input type="checkbox"/>	P.1170
ZP3B-T2AK15-B5		ZP3-04UM <input type="checkbox"/> ZP3-06UM <input type="checkbox"/> ZP3-08UM <input type="checkbox"/> ZP3-04B <input type="checkbox"/> ZP3-06B <input type="checkbox"/> ZP3-08B <input type="checkbox"/>	P.1170
ZP3B-T2AK20-B5		ZP3-04UM <input type="checkbox"/> ZP3-06UM <input type="checkbox"/> ZP3-08UM <input type="checkbox"/> ZP3-04B <input type="checkbox"/> ZP3-06B <input type="checkbox"/> ZP3-08B <input type="checkbox"/>	P.1170

缓冲器组件型号

缓冲器组件型号		适合吸盘型号 ZP3系列	页码
ZP3B-T2BJ3-B5		ZP3-10UM□ ZP3-13UM□ ZP3-16UM□ ZP3-10B□ ZP3-13B□ ZP3-16B□	P.1171
ZP3B-T2BJ6-B5		ZP3-10UM□ ZP3-13UM□ ZP3-16UM□ ZP3-10B□ ZP3-13B□ ZP3-16B□	P.1171
ZP3B-T2BJ10-B5		ZP3-10UM□ ZP3-13UM□ ZP3-16UM□ ZP3-10B□ ZP3-13B□ ZP3-16B□	P.1171
ZP3B-T2BK3-B5		ZP3-10UM□ ZP3-13UM□ ZP3-16UM□ ZP3-10B□ ZP3-13B□ ZP3-16B□	P.1171
ZP3B-T2BK6-B5		ZP3-10UM□ ZP3-13UM□ ZP3-16UM□ ZP3-10B□ ZP3-13B□ ZP3-16B□	P.1171
ZP3B-T2BK10-B5		ZP3-10UM□ ZP3-13UM□ ZP3-16UM□ ZP3-10B□ ZP3-13B□ ZP3-16B□	P.1171
ZP3B-T2BJB15-B5		ZP3-10UM□ ZP3-13UM□ ZP3-16UM□ ZP3-10B□ ZP3-13B□ ZP3-16B□	P.1171
ZP3B-T2BJB20-B5		ZP3-10UM□ ZP3-13UM□ ZP3-16UM□ ZP3-10B□ ZP3-13B□ ZP3-16B□	P.1171

缓冲器组件型号		适合吸盘型号 ZP3系列	页码
ZP3B-T2BK15-B5		ZP3-10UM□ ZP3-13UM□ ZP3-16UM□ ZP3-10B□ ZP3-13B□ ZP3-16B□	P.1171
ZP3B-T2BK20-B5		ZP3-10UM□ ZP3-13UM□ ZP3-16UM□ ZP3-10B□ ZP3-13B□ ZP3-16B□	P.1171
ZP3B-Y1J3-B3		ZP3-015U□ ZP3-02U□ ZP3-035U□	P.1172
ZP3B-Y1J6-B3		ZP3-015U□ ZP3-02U□ ZP3-035U□	P.1172
ZP3B-Y1K3-B3		ZP3-015U□ ZP3-02U□ ZP3-035U□	P.1172
ZP3B-Y1K6-B3		ZP3-015U□ ZP3-02U□ ZP3-035U□	P.1172

ZP3

ZP2

ZP2V

ZP

ZPT



ZPR

XT661



# ZP3 系列

## 缓冲器组件型号

缓冲器组件型号		适合吸盘型号	页码
		ZP3系列	
ZP3B-Y2AJ3-B5		ZP3-04UM□ ZP3-06UM□ ZP3-08UM□ ZP3-04B□ ZP3-06B□ ZP3-08B□	P.1172
ZP3B-Y2AJ6-B5		ZP3-04UM□ ZP3-06UM□ ZP3-08UM□ ZP3-04B□ ZP3-06B□ ZP3-08B□	P.1172
ZP3B-Y2AJ10-B5		ZP3-04UM□ ZP3-06UM□ ZP3-08UM□ ZP3-04B□ ZP3-06B□ ZP3-08B□	P.1172
ZP3B-Y2AK3-B5		ZP3-04UM□ ZP3-06UM□ ZP3-08UM□ ZP3-04B□ ZP3-06B□ ZP3-08B□	P.1172
ZP3B-Y2AK6-B5		ZP3-04UM□ ZP3-06UM□ ZP3-08UM□ ZP3-04B□ ZP3-06B□ ZP3-08B□	P.1172
ZP3B-Y2AK10-B5		ZP3-04UM□ ZP3-06UM□ ZP3-08UM□ ZP3-04B□ ZP3-06B□ ZP3-08B□	P.1172

缓冲器组件型号		适合吸盘型号	页码
		ZP3系列	
ZP3B-Y2AJB15-B5		ZP3-04UM□ ZP3-06UM□ ZP3-08UM□ ZP3-04B□ ZP3-06B□ ZP3-08B□	P.1172
ZP3B-Y2AJB20-B5		ZP3-04UM□ ZP3-06UM□ ZP3-08UM□ ZP3-04B□ ZP3-06B□ ZP3-08B□	P.1172
ZP3B-Y2AK15-B5		ZP3-04UM□ ZP3-06UM□ ZP3-08UM□ ZP3-04B□ ZP3-06B□ ZP3-08B□	P.1172
ZP3B-Y2AK20-B5		ZP3-04UM□ ZP3-06UM□ ZP3-08UM□ ZP3-04B□ ZP3-06B□ ZP3-08B□	P.1172

缓冲器组件型号

缓冲器组件型号		适合吸盘型号 ZP3系列	页码
ZP3B-Y2BJ3-B5		ZP3-10UM□ ZP3-13UM□ ZP3-16UM□ ZP3-10B□ ZP3-13B□ ZP3-16B□	P.1173
ZP3B-Y2BJ6-B5		ZP3-10UM□ ZP3-13UM□ ZP3-16UM□ ZP3-10B□ ZP3-13B□ ZP3-16B□	P.1173
ZP3B-Y2BJ10-B5		ZP3-10UM□ ZP3-13UM□ ZP3-16UM□ ZP3-10B□ ZP3-13B□ ZP3-16B□	P.1173
ZP3B-Y2BK3-B5		ZP3-10UM□ ZP3-13UM□ ZP3-16UM□ ZP3-10B□ ZP3-13B□ ZP3-16B□	P.1173
ZP3B-Y2BK6-B5		ZP3-10UM□ ZP3-13UM□ ZP3-16UM□ ZP3-10B□ ZP3-13B□ ZP3-16B□	P.1173
ZP3B-Y2BK10-B5		ZP3-10UM□ ZP3-13UM□ ZP3-16UM□ ZP3-10B□ ZP3-13B□ ZP3-16B□	P.1173

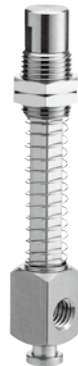
缓冲器组件型号		适合吸盘型号 ZP3系列	页码
ZP3B-Y2BJB15-B5		ZP3-10UM□ ZP3-13UM□ ZP3-16UM□ ZP3-10B□ ZP3-13B□ ZP3-16B□	P.1173
ZP3B-Y2BJB20-B5		ZP3-10UM□ ZP3-13UM□ ZP3-16UM□ ZP3-10B□ ZP3-13B□ ZP3-16B□	P.1173
ZP3B-Y2BK15-B5		ZP3-10UM□ ZP3-13UM□ ZP3-16UM□ ZP3-10B□ ZP3-13B□ ZP3-16B□	P.1173
ZP3B-Y2BK20-B5		ZP3-10UM□ ZP3-13UM□ ZP3-16UM□ ZP3-10B□ ZP3-13B□ ZP3-16B□	P.1173

<b>ZP3</b>
<b>ZP2</b>
<b>ZP2V</b>
<b>ZP</b>
ZPT
ZPR
XT661

# ZP3 系列 安装用连接器型号

真空引出方向 **纵**

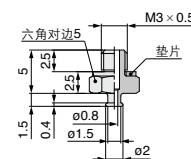
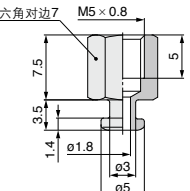
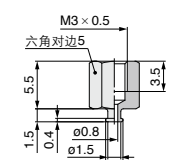
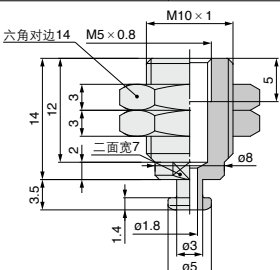
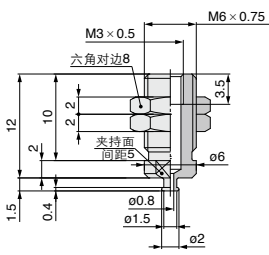
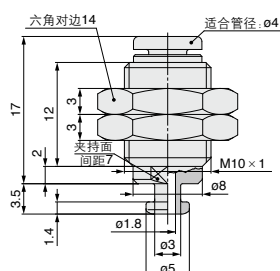
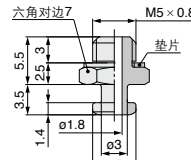
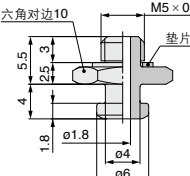
连接器型号	<b>ZP3A-T1-A3</b> [质量:0.5g]	连接器型号	<b>ZP3A-T2-B5</b> [质量:2.0g]
			
<p>适合吸盘型号</p> <p>ZP3-015U ZP3-02U ZP3-035U</p>		<p>适合吸盘型号</p> <p>ZP3-04UM ZP3-06UM ZP3-08UM ZP3-04B ZP3-06B ZP3-08B</p>	
连接器型号	<b>ZP3A-T1-B3</b> [质量:0.8g]	连接器型号	<b>ZP3A-T2-A10-B5</b> [质量:10.7g]
			
<p>适合吸盘型号</p> <p>ZP3-015U ZP3-02U ZP3-035U</p>		<p>适合吸盘型号</p> <p>ZP3-04UM ZP3-06UM ZP3-08UM ZP3-04B ZP3-06B ZP3-08B</p>	
连接器型号	<b>ZP3A-T1-A6-B3</b> [质量:2.7g]	连接器型号	<b>ZP3A-T2-A10-04</b> [质量:9.9g]
			
<p>适合吸盘型号</p> <p>ZP3-015U ZP3-02U ZP3-035U</p>		<p>适合吸盘型号</p> <p>ZP3-04UM ZP3-06UM ZP3-08UM ZP3-04B ZP3-06B ZP3-08B</p>	
连接器型号	<b>ZP3A-T2-A5</b> [质量:1.4g]	连接器型号	<b>ZP3A-T3-A5</b> [质量:2.4g]
			
<p>适合吸盘型号</p> <p>ZP3-04UM ZP3-06UM ZP3-08UM ZP3-04B ZP3-06B ZP3-08B</p>		<p>适合吸盘型号</p> <p>ZP3-10UM ZP3-13UM ZP3-16UM ZP3-10B ZP3-13B ZP3-16B</p>	

真空引出方向 **纵**

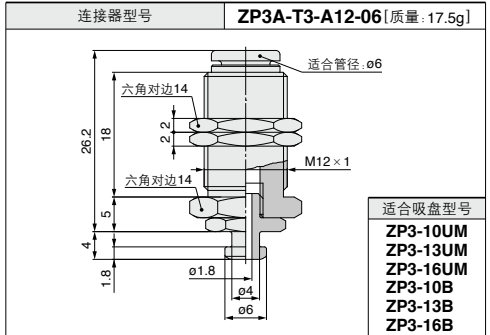
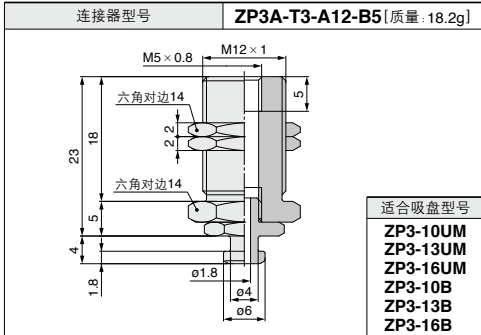
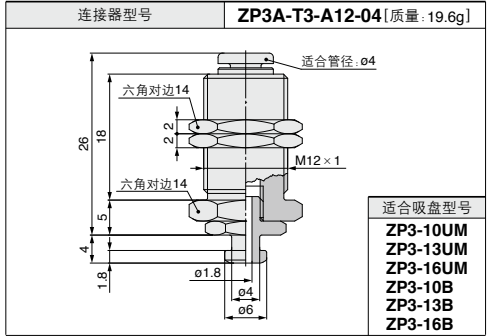
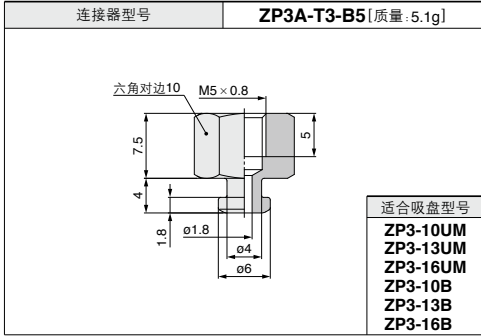

真空引出方向 **横**

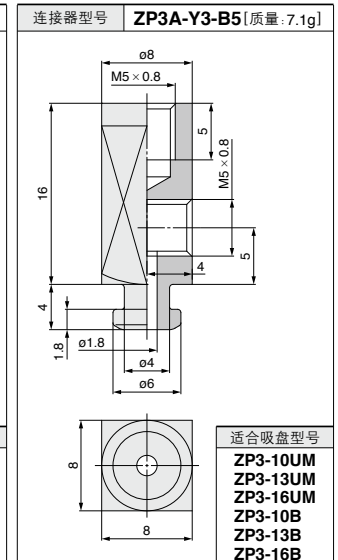
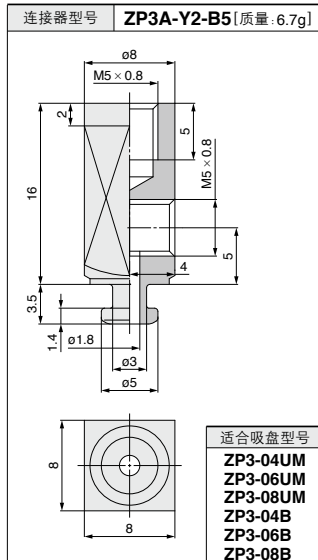
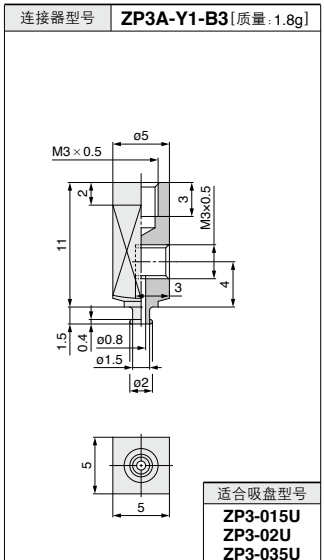

**ZP3**

**ZP2**

**ZP2V**

**ZP**

**ZPT**  
**ZPR**

**XT661**

# ZP3 系列 缓冲器组件型号

真空引出方向 **纵**

缓冲器组件型号	质量(g)
ZP3B-T1J3-B3	3.5
ZP3B-T1J6-B3	4.3
ZP3B-T1K3-B3	6.7
ZP3B-T1K6-B3	8.1

ZP3B-T1J-B3

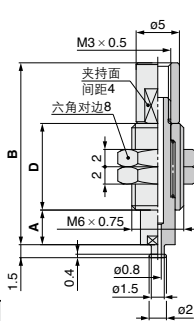

ZP3B-T1K-B3

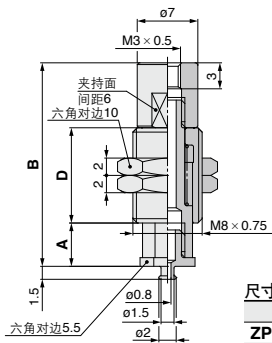

适合吸盘型号  
ZP3-015U  
ZP3-02U  
ZP3-035U

尺寸表(随行程而不同)

型号	A	B	D
ZP3B-T1J3-B3	4	21	10
ZP3B-T1J6-B3	7	28	14

尺寸表(随行程而不同)

型号	A	B	D
ZP3B-T1K3-B3	5	23.5	11
ZP3B-T1K6-B3	8	30	14.5

缓冲器组件型号	质量(g)
ZP3B-T2AJ3-B5	7.1
ZP3B-T2AJ6-B5	8.3
ZP3B-T2AJ10-B5	10.2
ZP3B-T2AK3-B5	7.0
ZP3B-T2AK6-B5	8.3
ZP3B-T2AK10-B5	10.2

ZP3B-T2AJ-B5

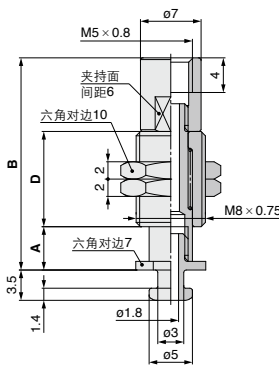

ZP3B-T2AK-B5

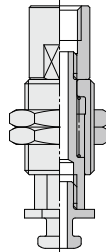

适合吸盘型号  
ZP3-04UM  
ZP3-06UM  
ZP3-08UM  
ZP3-04B  
ZP3-06B  
ZP3-08B

尺寸表(随行程而不同)

型号	A	B	D
ZP3B-T2A☆3-B5	5	24.5	11
ZP3B-T2A☆6-B5	8	31	14.5
ZP3B-T2A☆10-B5	12	41	20.5

注) 表中☆表示缓冲器规格「J, K」。

缓冲器组件型号	质量(g)
ZP3B-T2AJB15-B5	10.0
ZP3B-T2AJB20-B5	10.6
ZP3B-T2AK15-B5	12.0
ZP3B-T2AK20-B5	13.1

ZP3B-T2AJB-B5

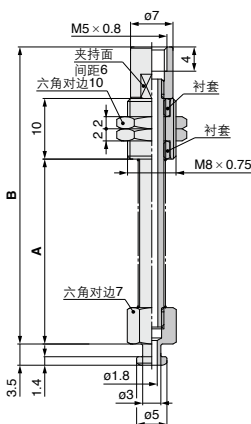

ZP3B-T2AK-B5

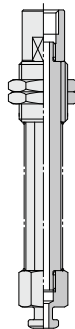

适合吸盘型号  
ZP3-04UM  
ZP3-06UM  
ZP3-08UM  
ZP3-04B  
ZP3-06B  
ZP3-08B

尺寸表(随行程而不同)

型号	A	B
ZP3B-T2A☆15-B5	30.5	49
ZP3B-T2A☆20-B5	38	56.5

注) 表中☆表示缓冲器规格「JB, K」。



※关于螺母的紧固力矩参见P.897。

真空引出方向 **纵**

缓冲器组件型号	质量(g)
ZP3B-T2BJ3-B5	7.8
ZP3B-T2BJ6-B5	8.9
ZP3B-T2BJ10-B5	10.9
ZP3B-T2BK3-B5	7.7
ZP3B-T2BK6-B5	8.9
ZP3B-T2BK10-B5	10.9

ZP3B-T2BJ-B5

ZP3B-T2BK-B5

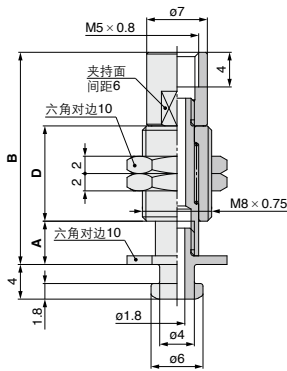

适合吸盘型号
ZP3-10UM
ZP3-13UM
ZP3-16UM
ZP3-10B
ZP3-13B
ZP3-16B

尺寸表(随行程而不同)

型号	A	B	D
ZP3B-T2B☆3-B5	5	24.5	11
ZP3B-T2B☆6-B5	8	31	14.5
ZP3B-T2B☆10-B5	12	41	20.5

注)表中☆表示缓冲器规格「J, K」。

缓冲器组件型号	质量(g)
ZP3B-T2BJB15-B5	12.5
ZP3B-T2BJB20-B5	15.6
ZP3B-T2BK15-B5	14.5
ZP3B-T2BK20-B5	15.6

ZP3B-T2BJB-B5

ZP3B-T2BK-B5

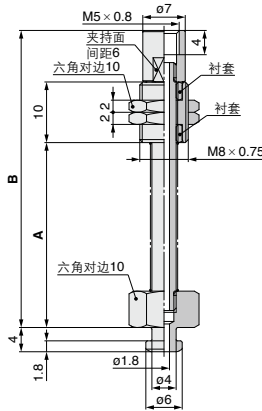

适合吸盘型号
ZP3-10UM
ZP3-13UM
ZP3-16UM
ZP3-10B
ZP3-13B
ZP3-16B

尺寸表(随行程而不同)

型号	A	B
ZP3B-T2B☆15-B5	30.5	49
ZP3B-T2B☆20-B5	38	56.5

注)表中☆表示缓冲器规格「JB, K」。

ZP3

ZP2

ZP2V

ZP

ZPT

ZPR

XT661

## 真空引出方向 **横**

缓冲器组件型号	质量(g)	适合吸盘型号
ZP3B-Y1J3-B3	7.6	ZP3-015U
ZP3B-Y1J6-B3	8.5	ZP3-02U
ZP3B-Y1K3-B3	10.9	ZP3-035U
ZP3B-Y1K6-B3	12.1	

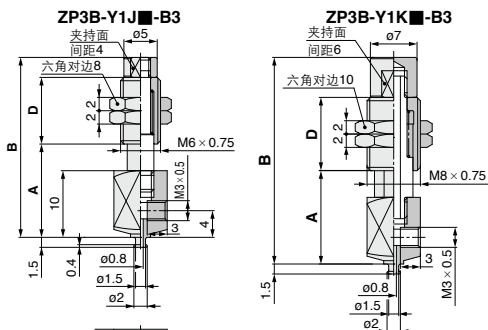

尺寸表(随行程而不同)

型号	A	B	D
ZP3B-Y1J3-B3	14	27	10
ZP3B-Y1J6-B3	17	34	14

尺寸表(随行程而不同)

型号	A	B	D
ZP3B-Y1K3-B3	14	31	11
ZP3B-Y1K6-B3	17	37.5	14.5

缓冲器组件型号	质量(g)	适合吸盘型号
ZP3B-Y2AJ3-B5	12.5	ZP3-04UM
ZP3B-Y2AJ6-B5	13.9	ZP3-06UM
ZP3B-Y2AJ10-B5	16.3	ZP3-08UM
ZP3B-Y2AK3-B5	11.9	ZP3-04B
ZP3B-Y2AK6-B5	13.1	ZP3-06B
ZP3B-Y2AK10-B5	15.1	ZP3-08B

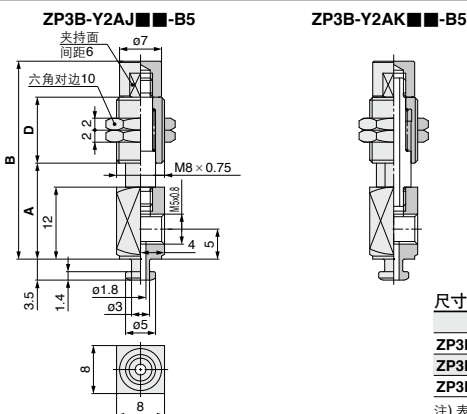

尺寸表(随行程而不同)

型号	A	B	D
ZP3B-Y2A☆3-B5	16.5	34	11
ZP3B-Y2A☆6-B5	19	40	14.5
ZP3B-Y2A☆10-B5	23	50	20.5

(注) 表中☆表示缓冲器规格「J, K」。

缓冲器组件型号	质量(g)	适合吸盘型号
ZP3B-Y2AJB15-B5	14.0	ZP3-04UM
ZP3B-Y2AJB20-B5	14.8	ZP3-06UM
ZP3B-Y2AK15-B5	15.2	ZP3-08UM
ZP3B-Y2AK20-B5	16.3	ZP3-04B
		ZP3-06B
		ZP3-08B

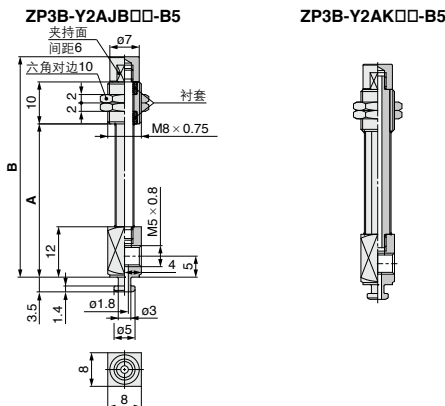

尺寸表(随行程而不同)

型号	A	B
ZP3B-Y2A☆15-B5	36.5	53
ZP3B-Y2A☆20-B5	44	60.5

(注) 表中☆表示缓冲器规格「JB, KB」。

※关于螺母的紧固力矩参见P.897。

真空引出方向 **横**

缓冲器组件型号	质量(g)
ZP3B-Y2BJ3-B5	13.0
ZP3B-Y2BJ6-B5	14.3
ZP3B-Y2BJ10-B5	16.7
ZP3B-Y2BK3-B5	12.4
ZP3B-Y2BK6-B5	13.6
ZP3B-Y2BK10-B5	15.5

ZP3B-Y2BJ ■■-B5

ZP3B-Y2BK ■■-B5

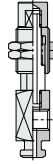
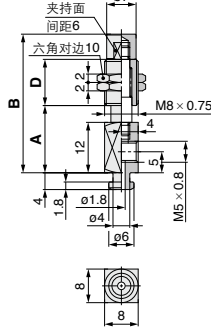

适合吸盘型号

- ZP3-10UM
- ZP3-13UM
- ZP3-16UM
- ZP3-10B
- ZP3-13B
- ZP3-16B

尺寸表(随行程而不同)

型号	A	B	D
ZP3B-Y2B☆3-B5	16.5	34	11
ZP3B-Y2B☆6-B5	19	40	14.5
ZP3B-Y2B☆10-B5	23	50	20.5

注) 表中☆表示缓冲器规格「J, K」。

缓冲器组件型号	质量(g)
ZP3B-Y2BJB15-B5	14.4
ZP3B-Y2BJB20-B5	15.2
ZP3B-Y2BK15-B5	15.6
ZP3B-Y2BK20-B5	16.7

ZP3B-Y2BJB ■■-B5

ZP3B-Y2BK ■■-B5

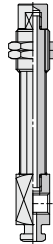
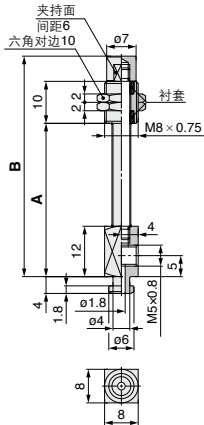

适合吸盘型号

- ZP3-10UM
- ZP3-13UM
- ZP3-16UM
- ZP3-10B
- ZP3-13B
- ZP3-16B

尺寸表(随行程而不同)

型号	A	B
ZP3B-Y2B☆15-B5	36.5	53
ZP3B-Y2B☆20-B5	44	60.5

注) 表中☆表示缓冲器规格「JB, K」。

ZP3

ZP2

ZP2V

ZP

ZPT

ZPR

XT661