

10-/21- 11-/22-CQS系列

薄型气缸紧凑型
 $\phi 12, \phi 16, \phi 20, \phi 25$

型号表示方法

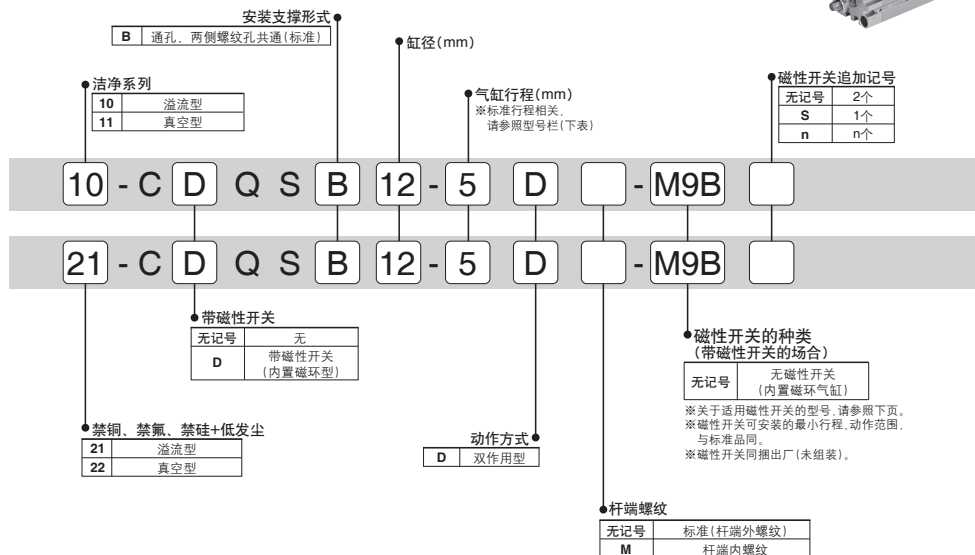
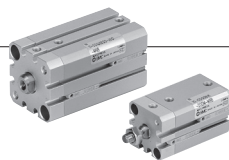

型式

型号		缸径(mm)	配管径	溢流/真空	动作方式	标准行程(mm)
溢流型	10-/21-CQSB12	12	M5×0.8	M5×0.8	双作用型 单杆	5, 10, 15, 20, 25, 30
	10-/21-CQSB16	16				5, 10, 15, 20, 25, 30, 35, 40, 45, 50
	10-/21-CQSB20	20				5, 10, 15, 20, 25, 30
	10-/21-CQSB25	25				5, 10, 15, 20, 25, 30
真空型	11-/22-CQSB12	12				5, 10, 15, 20, 25, 30, 35, 40, 45, 50
	11-/22-CQSB16	16				5, 10, 15, 20, 25, 30
	11-/22-CQSB20	20				5, 10, 15, 20, 25, 30, 35, 40, 45, 50
	11-/22-CQSB25	25				5, 10, 15, 20, 25, 30

规格

项目	缸径(mm)
保证耐压力	1.5MPa
最高使用压力	1.0MPa
最低使用压力	$\phi 12, \phi 16$: 0.07MPa, $\phi 20, \phi 25$: 0.05MPa
环境温度及使用流体温度	无磁性开关: $-10^{\circ}\text{C} \sim 70^{\circ}\text{C}$ 。 带磁性开关: $-10^{\circ}\text{C} \sim 60^{\circ}\text{C}$ (但不能结冻)
缓冲	无
使用活塞速度	30-400mm/s
行程长度公差	+1.0
安装	通孔、两端螺纹孔共通
使用润滑脂	10-/11-: 氟润滑脂 21-/22-: 锂皂基系润滑脂
洁净度等级(ISO等级)	10-/21-: 等级4 11-/22-: 等级3

真空型的抽吸流量(参考值)

尺寸	抽吸流量L/min(ANR)
12,16,20,25	5

磁性开关规格(规格详细及下述以外磁性开关, 请参照官网产品目录。)

触点	磁性开关型号	负载电压	负载电流范围	指示灯	适用用途
有触点	D-A93	DC24V, AC100V	5~40mA, 5~20mA	○	继电器、PLC
无触点	2线式 D-M9B	DC24VDC(10~28V)	2.5~40mA	○	DC24V继电器、PLC用
	3线式 D-M9N, D-M9P	DC28V以下	40mA以下	○	IC回路、继电器、PLC用

适用磁性开关一览 → 参照P.889 PLC: 可编程逻辑控制器

磁性开关/行程末端检测时合适的安装位置及安装高度

D-A93型

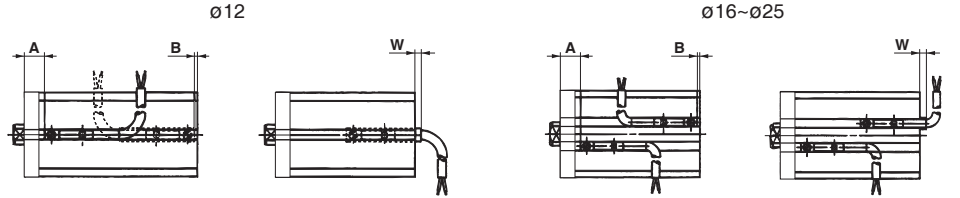

D-M9B/M9N型

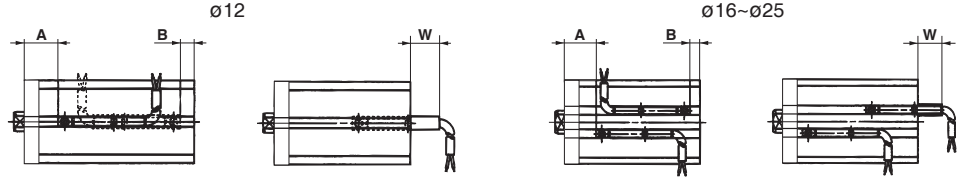

缸径 (mm)	D-A93型			D-M9B/M9N/M9P型		
	A	B	W	A	B	W
12	11.5	0.5	4	15.5	4.5	5.5
16	12	0	4.5	16	4	6
20	16	3.5	1	20	7.5	2.5
25	17	5.5	-1	21	9.5	0.5

⚠ 产品单独注意事项

使用前必读。

安装注意事项

⚠ 注意

- ① 如右图气缸周围与磁性体密切接触的场合(包含任何一面接近的场合), 磁性开关的动作会不稳定, 需由本公司确认。

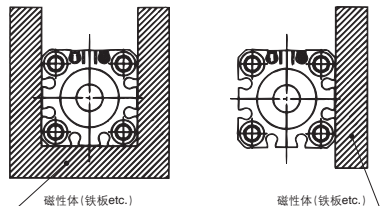

方向控制元件

气缸

摆缸

气爪

压缩空气净化元件

模块式F.R

压力控制元件

接头管子

驱动控制元件

压力传感器

标准型 / 19-CQSB12~25, 22-CQSB12~25

ø12

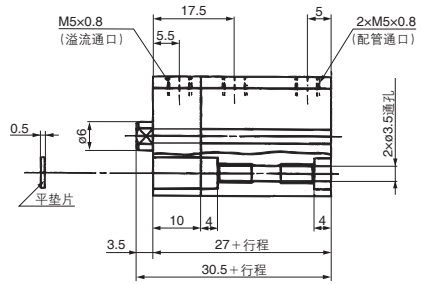
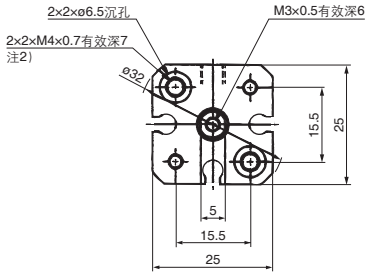

ø16

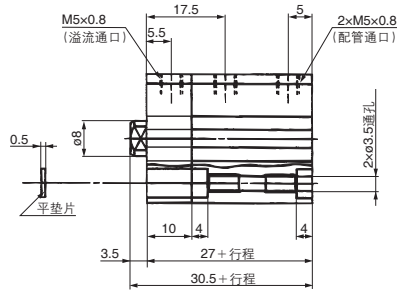
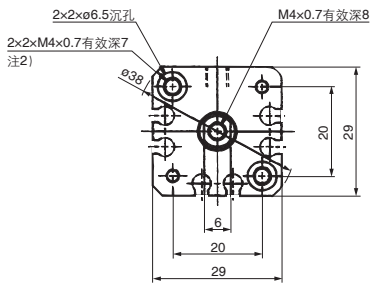

ø20

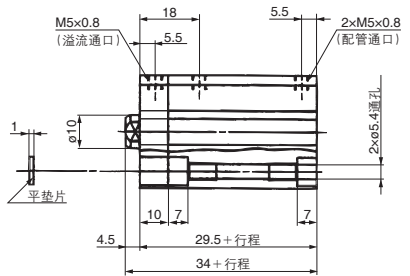
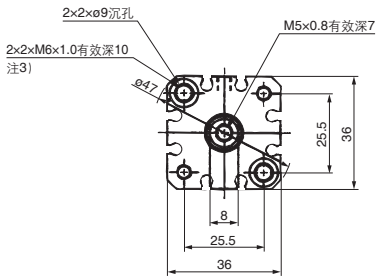

ø25

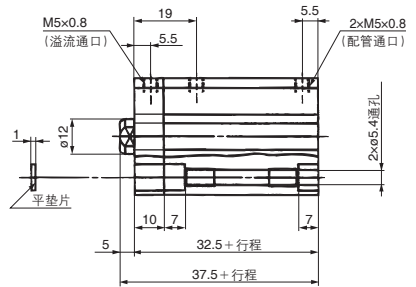
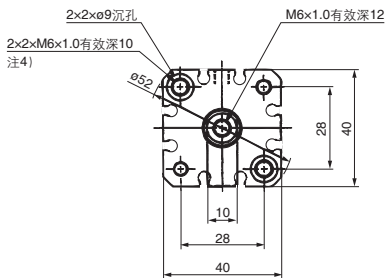

注1) 行程以5mm位间隔。 注2) 5行程の場合、为贯通螺孔。
注3) 5-15行程の場合、为贯通螺孔。 注4) 5,10行程の場合、为贯通螺孔。

标准型杆端外螺纹¹⁰:CQSB12~25,²¹:CQSB12~25

ø12

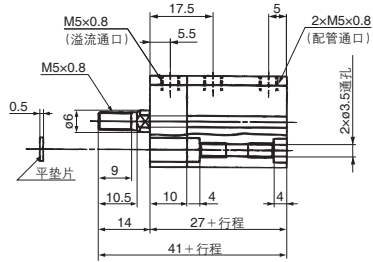
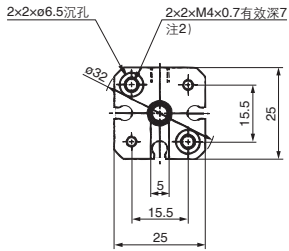

杆端螺母

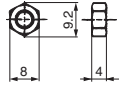

ø16

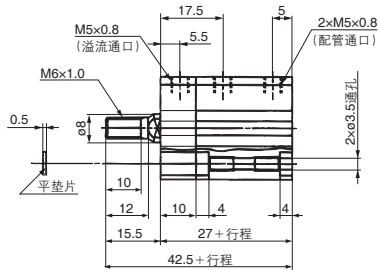
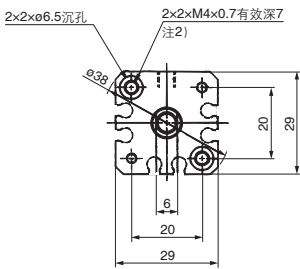

杆端螺母

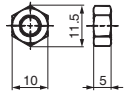

ø20

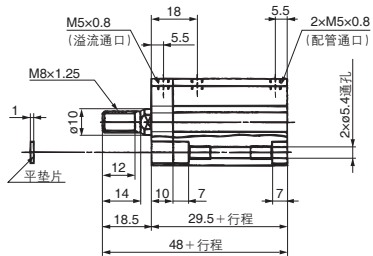
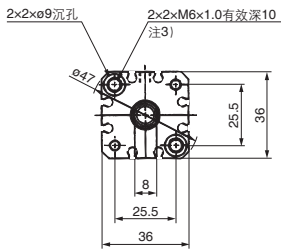

杆端螺母

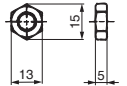

ø25

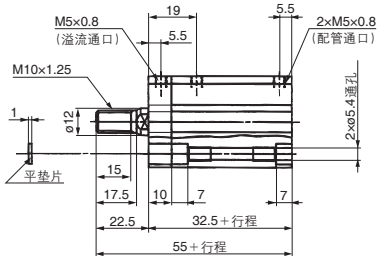
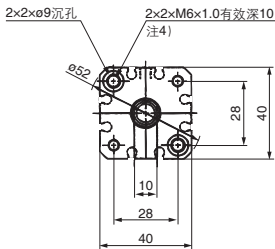

杆端螺母

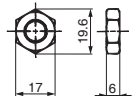

注1)行程以5mm为间隔。注2)5行程の場合、为贯通螺孔。
注3)5-15行程の場合、为贯通螺孔。注4)5,10行程の場合、为贯通螺孔。

方向控制元件

气缸

摆缸

气爪

净化压缩空气

模块式F.R.

压力控制元件

接头管子

驱动控制元件

压力传感器

带磁性开关¹⁾CDQSB12~25²⁾ CDQSB12~25

ø12

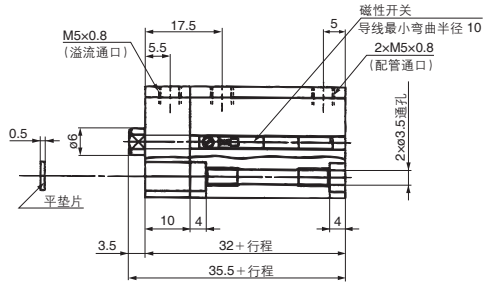
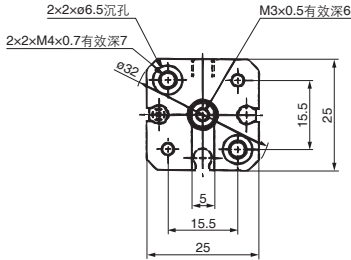

ø16

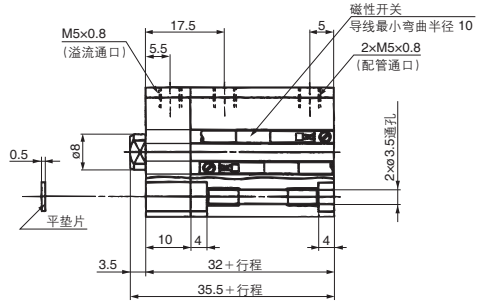
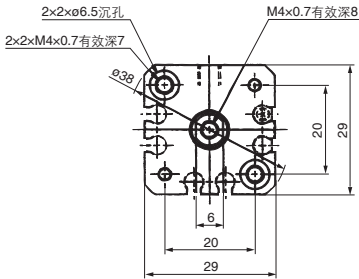

ø20

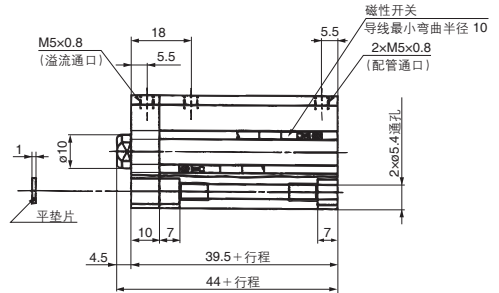
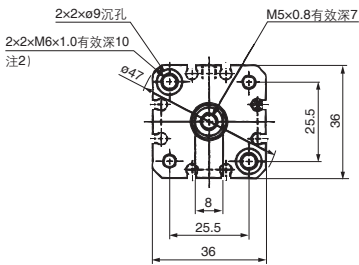

ø25

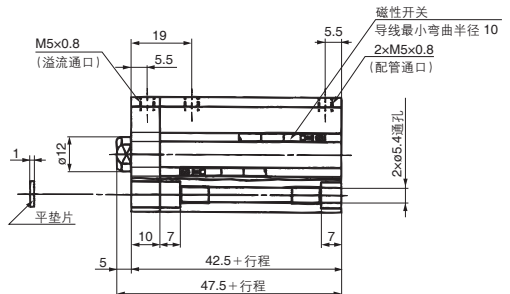
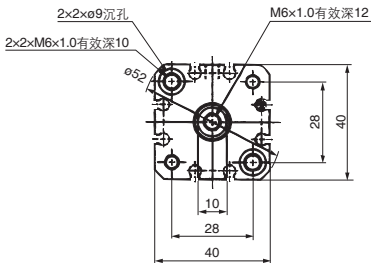

注1) 行程以5mm为间隔。注2) 5行程の場合、为贯通螺孔。

带磁性开关杆端外螺纹/¹⁰CDQSB12~25,²¹CDQSB12~25

ø12

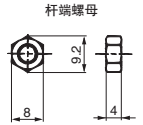
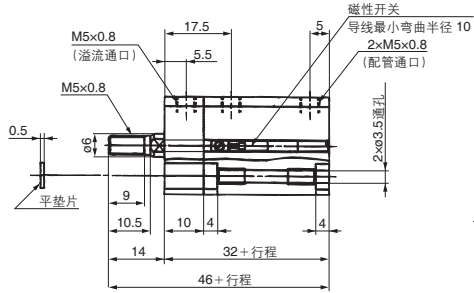
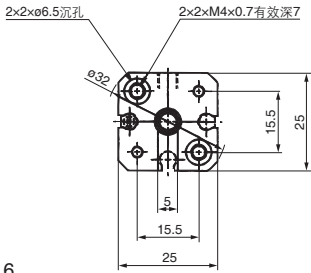

ø16

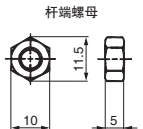
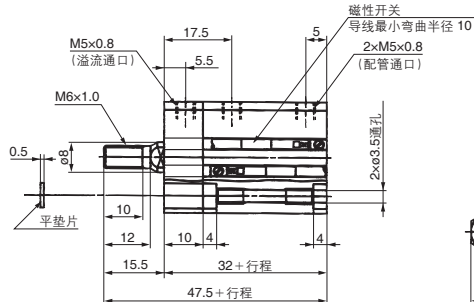
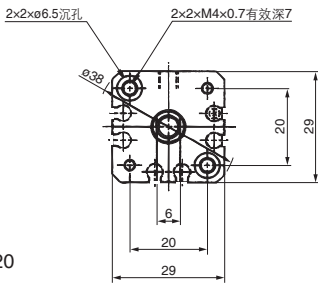

ø20

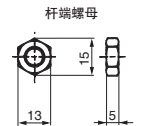
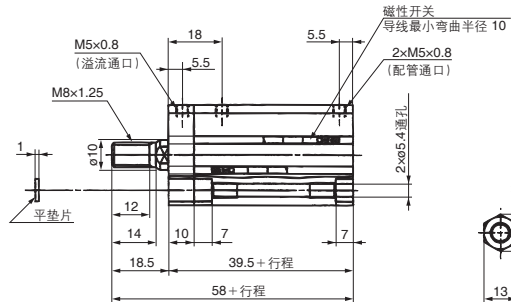
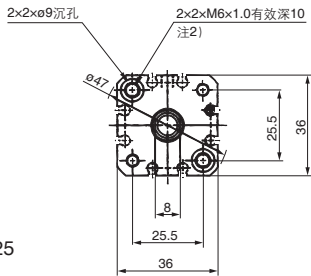

ø25

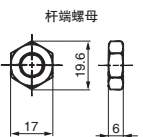
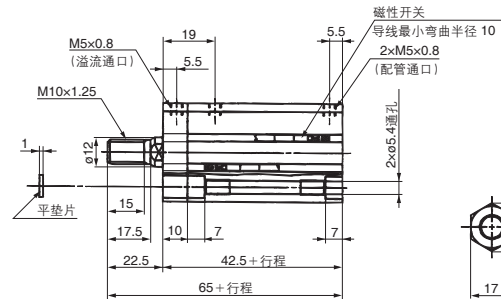
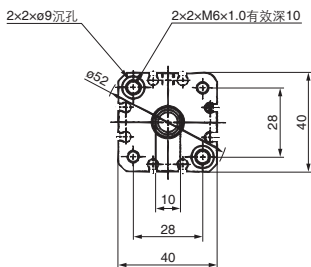

注1) 行程以5mm为间隔。注2) 5行程の場合、为贯通螺孔。

方向控制元件

气缸

摆缸

气爪

净化压缩空气

模块式F.R

压力控制元件

接头管子

驱动控制元件

压力传感器

CQS用安装螺栓

安装方法：备有通孔型CQSB用安装螺栓。
 购买方法参照下面内容。
 购买数量根据螺栓根数决定。

例) CQ-M3X35L 2根

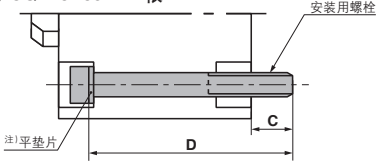

注) 通孔安装气缸时，必须使用添附的平垫片。

杆侧安装/无磁性开关

型号		C	D	安装螺栓型号
10-21-	11-22-	6.5	35	CQ-M3X35L
			40	X40L
			45	X45L
			50	X50L
			55	X55L
			60	X60L
10-21-	11-22-	6.5	35	CQ-M3X35L
			40	X40L
			45	X45L
			50	X50L
			55	X55L
			60	X60L
10-21-	11-22-	6.5	35	CQ-M5X35L
			40	X40L
			45	X45L
			50	X50L
			55	X55L
			60	X60L
			65	X65L
			70	X70L
			75	X75L
			80	X80L
10-21-	11-22-	8.5	40	CQ-M5X40L
			45	X45L
			50	X50L
			55	X55L
			60	X60L
			65	X65L
			70	X70L
			75	X75L
			80	X80L
			85	X85L

无杆侧安装/无磁性开关

型号		C	D	安装螺栓型号
10-21-	11-22-	6.5	25	CQ-M3X25L
			30	X30L
			35	X35L
			40	X40L
			45	X45L
			50	X50L
10-21-	11-22-	6.5	25	CQ-M3X25L
			30	X30L
			35	X35L
			40	X40L
			45	X45L
			50	X50L
10-21-	11-22-	6.5	25	CQ-M5X25L
			30	X30L
			35	X35L
			40	X40L
			45	X45L
			50	X50L
			55	X55L
			60	X60L
			65	X65L
			70	X70L
10-21-	11-22-	8.5	30	CQ-M5X30L
			35	X35L
			40	X40L
			45	X45L
			50	X50L
			55	X55L
			60	X60L
			65	X65L
			70	X70L
			75	X75L

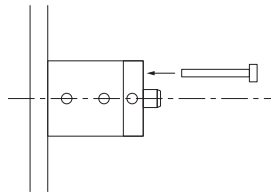
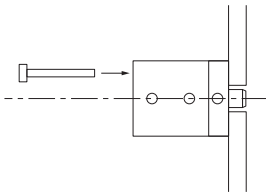

CDQS用安装螺栓

安装方法：备有通孔型CDQSB用安装螺栓。
 购买方法参照下面内容。
 购买数量根据螺栓根数决定。

例) CQ-M3X40L 2根

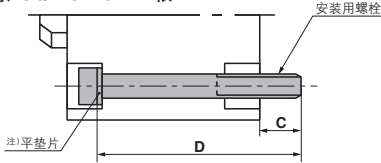

注) 通孔安装气缸时，必须使用添附的平垫片。

杆侧安装/带磁性开关

型号		C	D	安装螺栓型号
10-21-	11-22-	6.5	40	CQ-M3X40L
			45	X45L
			50	X50L
			55	X55L
			60	X60L
			65	X65L
10-21-	11-22-	6.5	40	CQ-M3X40L
			45	X45L
			50	X50L
			55	X55L
			60	X60L
			65	X65L
10-21-	11-22-	6.5	45	CQ-M5X45L
			50	X50L
			55	X55L
			60	X60L
			65	X65L
			70	X70L
			75	X75L
			80	X80L
			85	X85L
			90	X90L
10-21-	11-22-	8.5	50	CQ-M5X50L
			55	X55L
			60	X60L
			65	X65L
			70	X70L
			75	X75L
			80	X80L
			85	X85L
			90	X90L
			95	X95L

无杆侧安装/带磁性开关

型号		C	D	安装螺栓型号
10-21-	11-22-	6.5	30	CQ-M3X30L
			35	X35L
			40	X40L
			45	X45L
			50	X50L
			55	X55L
10-21-	11-22-	6.5	30	CQ-M3X30L
			35	X35L
			40	X40L
			45	X45L
			50	X50L
			55	X55L
10-21-	11-22-	6.5	35	CQ-M5X35L
			40	X40L
			45	X45L
			50	X50L
			55	X55L
			60	X60L
			65	X65L
			70	X70L
			75	X75L
			80	X80L
10-21-	11-22-	8.5	40	CQ-M5X40L
			45	X45L
			50	X50L
			55	X55L
			60	X60L
			65	X65L
			70	X70L
			75	X75L
			80	X80L
			85	X85L

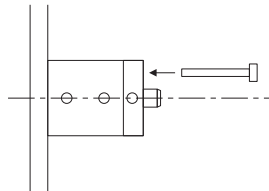
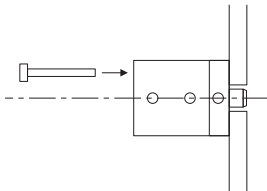

方向控制元件

气缸

摆缸

气爪

净化压缩空气

模块式F.R

压力控制元件

接头管子

驱动控制元件

压力传感器