

带单向阀的快插接头

KKK 系列

不锈钢型

RoHS



- 接头体材质: 不锈钢(SUS304)
密封部材质: 采用氟橡胶(特殊FKM)
- 插头·插座内置单向阀
根据使用条件, 可选择有无单向阀
- 插头·插座脱离时的内部液体泄漏量减少
液体泄漏量: $0.02\sim 0.77\text{cm}^3/\text{次}$ 空气混入量: $0.1\sim 2.7\text{cm}^3/\text{次}$

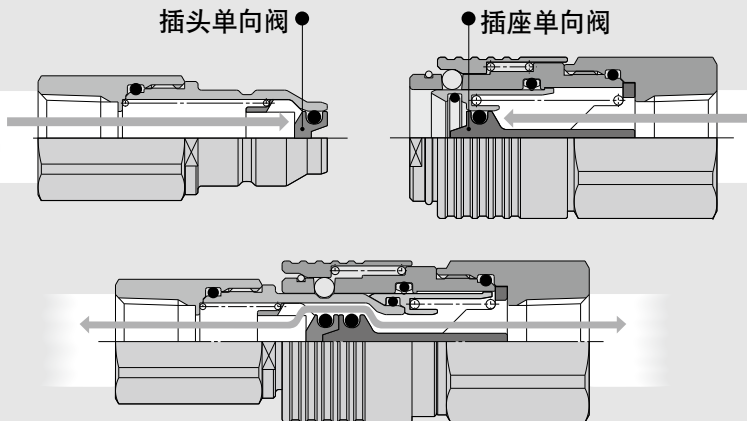

- 无润滑脂规格(标准)
虽不使用润滑脂, 仍可灵活装拆。
 - O形圈: 氟涂层
 - 插头、插座的滑动部: 采用含氟涂层。
- 使用流体: 水、空气
- 使用温度范围: $-5\sim 150^\circ\text{C}$
注) 避免在蒸汽环境下使用。

KQ2

KQB2

KS
KX

KM

KF

M

H/DL
L/LL

KC

KK

KK130

DM

KDM

KB

KR

KA

KQG2

KG

KFG2

MS

KKK

KP

LQ

MQR

T

插头(P)

外螺纹式

接头体尺寸	接管口径	型号	
		带单向阀	无单向阀
1/8	R1/8	KKA3P-01M	KKA3P-01M-1
	R1/4	-02M	-02M-1
	R3/8	-03M	-03M-1
1/4	R1/4	KKA4P-02M	KKA4P-02M-1
	R3/8	-03M	-03M-1
	R1/2	-04M	-04M-1
1/2	R3/8	KKA6P-03M	KKA6P-03M-1
	R1/2	-04M	-04M-1
	R3/4	-06M	-06M-1
3/4	R1/2	KKA7P-04M	-
	R3/4	-06M	-
	R1	-10M	-
1	R3/4	KKA8P-06M	-
	R1	-10M	-
	R1 1/4	-12M	-
1 1/4	R1	KKA9P-10M	-
	R1 1/4	-12M	-
	R1 1/2	-14M	-



带单向阀



无单向阀

内螺纹式

接头体尺寸	接管口径	型号	
		带单向阀	无单向阀
1/8	Rc1/8	KKA3P-01F	KKA3P-01F-1
	Rc1/4	-02F	-02F-1
	Rc3/8	-03F	-03F-1
1/4	Rc1/4	KKA4P-02F	KKA4P-02F-1
	Rc3/8	-03F	-03F-1
	Rc1/2	-04F	-04F-1
1/2	Rc3/8	KKA6P-03F	KKA6P-03F-1
	Rc1/2	-04F	-04F-1
	Rc3/4	-06F	-06F-1
3/4	Rc1/2	KKA7P-04F	-
	Rc3/4	-06F	-
	Rc1	-10F	-
1	Rc3/4	KKA8P-06F	-
	Rc1	-10F	-
	Rc1 1/4	-12F	-
1 1/4	Rc1	KKA9P-10F	-
	Rc1 1/4	-12F	-
	Rc1 1/2	-14F	-



带单向阀



无单向阀

插座(S)

外螺纹式

接头体尺寸	接管口径	型号	
		带单向阀	无单向阀
1/8	R1/8	KKA3S-01M	KKA3S-01M-1
	R1/4	-02M	-02M-1
	R3/8	-03M	-03M-1
1/4	R1/4	KKA4S-02M	KKA4S-02M-1
	R3/8	-03M	-03M-1
	R1/2	-04M	-04M-1
1/2	R3/8	KKA6S-03M	KKA6S-03M-1
	R1/2	-04M	-04M-1
	R3/4	-06M	-06M-1
3/4	R1/2	KKA7S-04M	-
	R3/4	-06M	-
	R1	-10M	-
1	R3/4	KKA8S-06M	-
	R1	-10M	-
	R1 1/4	-12M	-
1 1/4	R1	KKA9S-10M	-
	R1 1/4	-12M	-
	R1 1/2	-14M	-



内螺纹式

接头体尺寸	接管口径	型号	
		带单向阀	无单向阀
1/8	Rc1/8	KKA3S-01F	KKA3S-01F-1
	Rc1/4	-02F	-02F-1
	Rc3/8	-03F	-03F-1
1/4	Rc1/4	KKA4S-02F	KKA4S-02F-1
	Rc3/8	-03F	-03F-1
	Rc1/2	-04F	-04F-1
1/2	Rc3/8	KKA6S-03F	KKA6S-03F-1
	Rc1/2	-04F	-04F-1
	Rc3/4	-06F	-06F-1
3/4	Rc1/2	KKA7S-04F	-
	Rc3/4	-06F	-
	Rc1	-10F	-
1	Rc3/4	KKA8S-06F	-
	Rc1	-10F	-
	Rc1 1/4	-12F	-
1 1/4	Rc1	KKA9S-10F	-
	Rc1 1/4	-12F	-
	Rc1 1/2	-14F	-



产品单独注意事项由P.181~184确认。

对接式快插接头

KKK 系列

不锈钢型

RoHS



JIS图形符号

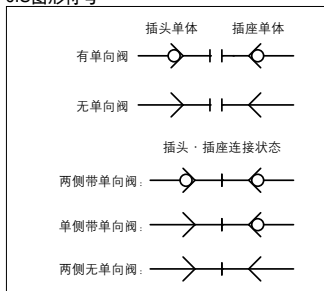

两侧带单向阀特性

接头体尺寸	液体泄漏量cm ³ /次	空气混入量cm ³ /次
KKA3	0.02	0.1
KKA4	0.04	0.1
KKA6	0.06	0.2
KKA7	0.14	0.5
KKA8	0.27	0.9
KKA9	0.77	2.7

液体泄漏量

指插头、插座脱离时，内部水的泄漏量。

空气混入量

指插头、插座连接时，外部空气的混入量。

规格

使用流体	水、空气
使用压力范围 注1)	KKA3: -100kPa~1MPa KKA4: 6·7·8·9: 0~1MPa
保证耐压力	10MPa
环境温度及使用流体温度	-5~150°C(但未冻结) 注)避免使用蒸气。
无润滑脂规格	不使用润滑脂。 (橡胶:氟涂层、金属滑动部:含氟镀层)
材质	金属件:SUS304、橡胶件:氟橡胶(特殊FKM)
密封	外螺纹带密封剂

注1) 因不能保证泄漏为零,故请不要用于泄漏实验等的真空保持。

性能

插头、插座连接方法	快速装拆
单向阀	可选择插头、插座内有无单向阀

注) KKA系列不能与KK及KKH系列连接。

有效截面积

单向阀有无	插头	插座	有效截面积mm ²
插头、插座两侧 都带单向阀	KKA3P-01F	KKA3S-01F	17.4
	KKA4P-02F	KKA4S-02F	26.4
	KKA6P-04F	KKA6S-04F	54.2
	KKA7P-06F	KKA7S-06F	99.6
	KKA8P-10F	KKA8S-10F	168.3
	KKA9P-12F	KKA9S-12F	332.1
插头:无单向阀 插座:带单向阀	KKA3P-01M-1	KKA3S-01M	18.5
	KKA4P-02M-1	KKA4S-02M	31.8
插头:无单向阀 插座:无单向阀	KKA6P-04M-1	KKA6S-04M	55.3
	KKA3P-01M-1	KKA3S-01M-1	22.6
插头:无单向阀 插座:无单向阀	KKA4P-02M-1	KKA4S-02M-1	40.2
	KKA6P-04M-1	KKA6S-04M-1	76.0

型号表示方法

KKK 4 P - 02 M

接头体尺寸

3	1/8
4	1/4
6	1/2
7	3/4
8	1
9	1 1/4

插座·插头区别

P	插头
S	插座

连接口径

记号	接管口径
01	R,Rc1/8
02	R,Rc1/4
03	R,Rc3/8
04	R,Rc1/2
06	R,Rc3/4
10	R,Rc1
12	R,Rc1 1/4
14	R,Rc1 1/2

单向阀有无

无记号	有单向阀
-1	无单向阀(注)

注) KKA7·8·9没有不带单向阀的,需要时另行商谈。

连接螺纹

记号	种类
M	外螺纹(带密封剂)
F	内螺纹

单向阀有无	插头	插座	可否使用
	有	有	○
无	有	○	
有	无	○	
无	无	×	

注) 使用带单向阀的插头时,请与带单向阀的插座组合使用。
若使用不带单向阀的插座,插头侧的单向阀不能开启。

KKA 系列

流量特性

空气

插头:带单向阀 插座:带单向阀

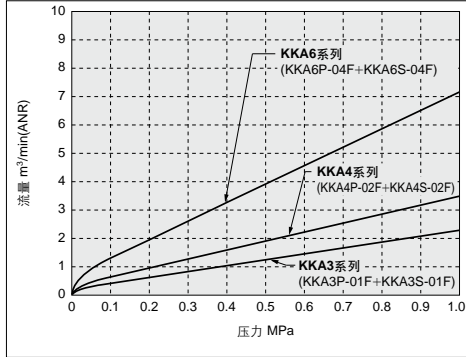

插头:带单向阀 插座:带单向阀

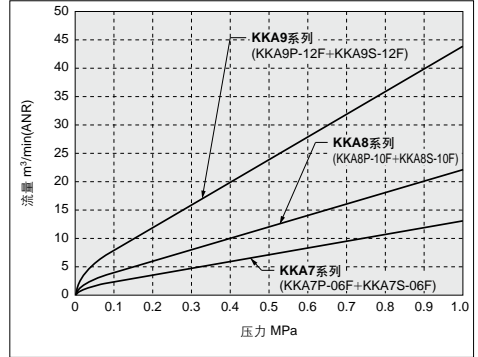

插头:无单向阀 插座:带单向阀

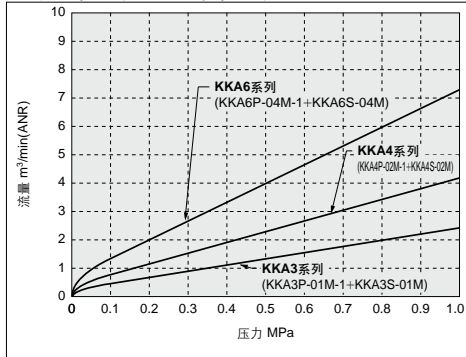

插头:无单向阀 插座:无单向阀

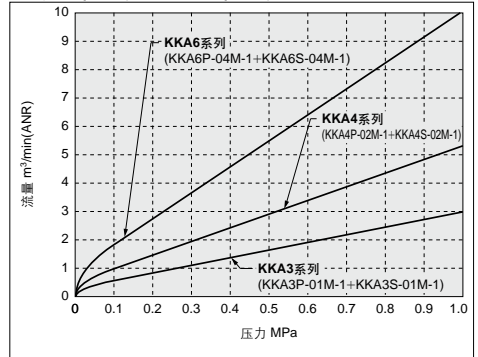

压力损失

水

插头:带单向阀 插座:带单向阀

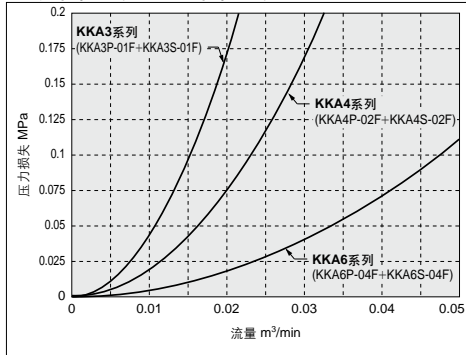

插头:带单向阀 插座:带单向阀

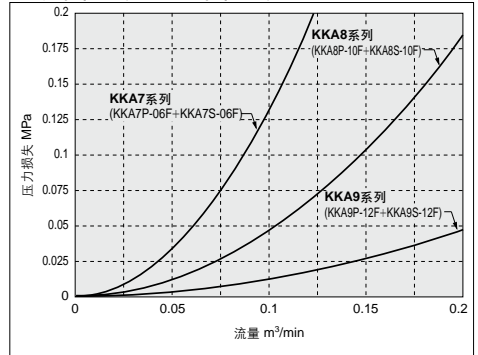

结构图

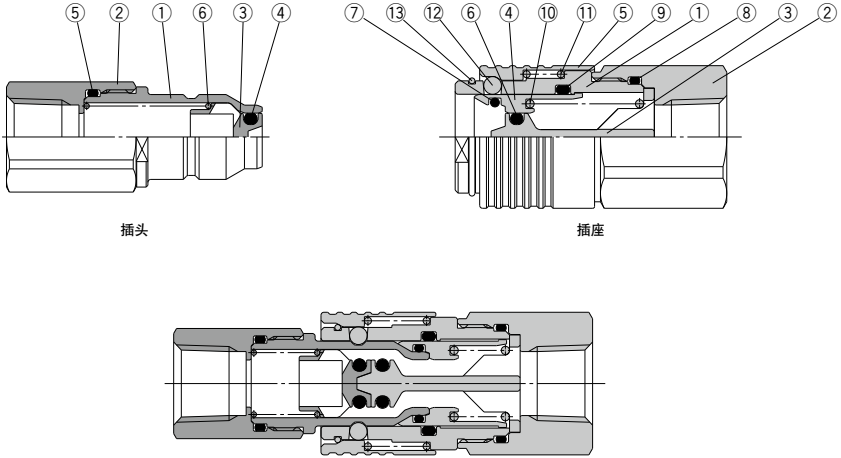

插头

序号	零部件名	材质	备注
1	插头体	SUS304	氟镀层
2	插头支持体	SUS304	
3	插头单向阀	SUS304	
4	阀芯O形圈	特殊FKM	氟镀层
5	插头体O形圈	特殊FKM	氟镀层
6	插头单向阀弹簧	相当SUS304	KKA3
		SUS304	KKA4, 6, 7, 8, 9

插座

序号	零部件名	材质	备注
1	插座体	SUS304	
2	插座支持体	SUS304	
3	插座单向阀	SUS304	
4	套环	SUS304	氟涂层
5	套筒	SUS304	含氟镀层
6	单向阀O形圈	特殊FKM	氟涂层
7	插头O形圈	特殊FKM	氟涂层
8	插座体O形圈	特殊FKM	氟涂层
9	套环密封圈	特殊FKM	氟涂层
10	套环弹簧	相当SUS304	KKA3, 4, 6
		SUS304	KKA7, 8, 9
11	套筒弹簧	SUS304	
12	钢球	SUS304	
13	止动环	SUS304	

KKA系列 备件

名称	产品型号	序号
插头O形圈	KKA3S-P01	插座⑦
	KKA4S-P01	
	KKA6S-P01	
	KKA7S-P01	
	KKA8S-P01	
	KKA9S-P01	

KQ2

KQB2

KS
KX

KM

KF

M

H/DL
L/LL

KC

KK

KK130

DM

KDM

KB

KR

KA

KQG2

KG

KFG2

MS

KKA

KP

LQ

MQR

T

KKA 系列

外形尺寸图 / 插头(P)

带单向阀

外螺纹式

(mm)



接头体尺寸	型号	T 接管口径	H 六角对边	L1	L2	A	最小孔径	有效截面积 mm ²	质量 g
1/8	KKA3P-01M	R1/8	14	35.4	16.0	31.4	5.6	17.4	15.4
	-02M	R1/4		38.4		32.4			19.8
	-03M	R3/8		39.4		32.9			32.9
1/4	KKA4P-02M	R1/4	17	42.2	18.9	36.2	6.9	26.4	28.3
	-03M	R3/8		43.2		36.7			36.6
	-04M	R1/2		46.2		38.2			65.9
1/2	KKA6P-03M	R3/8	24	47.1	20.4	40.6	10.0	54.2	60.3
	-04M	R1/2		47.9		39.9			69.2
	-06M	R3/4		49.9		40.4			119.0
3/4	KKA7P-04M	R1/2	32	66.3	27.6	58.1	13.5	99.6	173.9
	-06M	R3/4		69.4		59.9			209.6
	-10M	R1		69.9		59.5			275.0
1	KKA8P-06M	R3/4	41	82.9	35.6	73.4	17.5	168.3	362.8
	-10M	R1		85.4		75.0			403.9
	-12M	R1 1/4		85.4		72.7			538.6
1 1/4	KKA9P-10M	R1	55	109.5	49.1	99.1	24.6	332.1	824.1
	-12M	R1 1/4		109.0		96.3			861.4
	-14M	R1 1/2		109.0		96.3			936.3

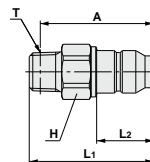

内螺纹式

(mm)



接头体尺寸	型号	T 接管口径	H 六角对边	L1	L2	最小孔径	有效截面积 mm ²	质量 g
1/8	KKA3P-01F	Rc1/8	14	36.0	16.0	5.6	17.4	20.2
	-02F	Rc1/4		39.6				31.8
	-03F	Rc3/8		40.4				35.8
1/4	KKA4P-02F	Rc1/4	17	43.4	18.9	6.9	26.4	36.1
	-03F	Rc3/8		44.4				40.2
	-04F	Rc1/2		48.6				69.7
1/2	KKA6P-03F	Rc3/8	24	48.7	20.4	10.0	54.2	84.1
	-04F	Rc1/2		52.9				79.7
	-06F	Rc3/4		54.6				123.8
3/4	KKA7P-04F	Rc1/2	32	67.7	27.6	13.5	99.6	217.1
	-06F	Rc3/4		69.4				196.8
	-10F	Rc1		72.4				325.9
1	KKA8P-06F	Rc3/4	41	82.0	35.6	17.5	168.3	420.5
	-10F	Rc1		85.0				391.3
	-12F	Rc1 1/4		87.3				552.8
1 1/4	KKA9P-10F	Rc1	55	107.8	49.1	24.6	332.1	986.9
	-12F	Rc1 1/4		110.1				925.6
	-14F	Rc1 1/2		110.1				848.2

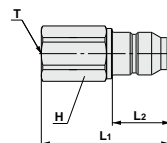

外形尺寸图 / 插座(S)

带单向阀
外螺纹式

(mm)



接头体尺寸	型号	T 接管口径	H 六角对边	øD	L	A	最小孔径	有效截面积 mm ²	质量 g
1/8	KKA3S-01M	R1/8	17	18.5	38.1	34.1	5.9	18.5	38.5
	-02M	R1/4			41.1	35.1			41.8
	-03M	R3/8			42.1	35.6			46.3
1/4	KKA4S-02M	R1/4	22	24.2	46.0	40.0	7.7	31.8	76.8
	-03M	R3/8			47.0	40.5			78.5
	-04M	R1/2			50.0	42.0			86.6
1/2	KKA6S-03M	R3/8	30	30.7	51.4	44.9	10.2	55.3	149.1
	-04M	R1/2			54.4	46.4			160.4
	-06M	R3/4			56.4	46.9			184.8
3/4	KKA7S-04M	R1/2	36	42.5	76.3	68.1	13.6	101.5	426.1
	-06M	R3/4			79.3	69.8			457.8
	-10M	R1			82.8	72.4			514.0
1	KKA8S-06M	R3/4	46	55	94.9	85.4	17.6	169.9	873.5
	-10M	R1			98.4	88.0			931.1
	-12M	R1 1/4			100.4	87.7			1012.9
1 1/4	KKA9S-10M	R1	63	69	125.5	115.1	22.0	264.9	1680.7
	-12M	R1 1/4			127.5	114.8			1758.1
	-14M	R1 1/2			127.5	114.8			1819.4

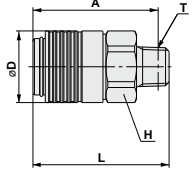

内螺纹式

(mm)

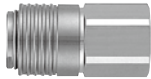

接头体尺寸	型号	T 接管口径	H 六角对边	øD	L	最小孔径	有效截面积 mm ²	质量 g
1/8	KKA3S-01F	Rc1/8	17	18.5	37.6	5.9	18.5	46.9
	-02F	Rc1/4			41.2			47.2
	-03F	Rc3/8			43.1			52.3
1/4	KKA4S-02F	Rc1/4	22	24.2	46.1	7.7	31.8	97.1
	-03F	Rc3/8			46.9			91.1
	-04F	Rc1/2			52.3			104.3
1/2	KKA6S-03F	Rc3/8	30	30.7	50.5	10.2	55.3	189.6
	-04F	Rc1/2			56.2			202.0
	-06F	Rc3/4			57.9			180.6
3/4	KKA7S-04F	Rc1/2	36	42.5	75.1	13.6	101.5	477.2
	-06F	Rc3/4			76.5			457.4
	-10F	Rc1			82.3			550.9
1	KKA8S-06F	Rc3/4	46	55	90.9	17.6	169.9	935.2
	-10F	Rc1			93.9			914.7
	-12F	Rc1 1/4			99.2			1002.1
1 1/4	KKA9S-10F	Rc1	63	69	121.8	25.1	344.9	1919.1
	-12F	Rc1 1/4			121.8			1810.0
	-14F	Rc1 1/2			121.8			1732.6

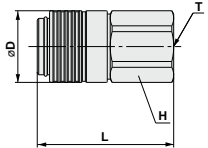

- KQ2
- KQB2
- KS
KX
- KM
- KF
- M
- H/DL
L/LL
- KC
- KK
- KK130
- DM
- KDM
- KB
- KR
- KA
- KQG2
- KG
- KFG2
- MS
- KKA**
- KP
- LQ
- MQR
- T

KKA 系列

外形尺寸图 / 插头(P)

无单向阀

外螺纹式

(mm)



接头体尺寸	型号	T 接管口径	H 六角对边	L1	L2	A	最小孔径	有效截面积 mm ²	质量 g
1/8	KKA3P-01M-1	R1/8	12	28.5	16.0	24.5	6.0	22.6	9.8
	-02M-1	R1/4	14	31.5		25.5			14.6
	-03M-1	R3/8	17	32.5		26.0			23.6
1/4	KKA4P-02M-1	R1/4	17	34.4	18.9	28.4	8.0	40.2	21.0
	-03M-1	R3/8		35.4		28.9			27.9
	-04M-1	R1/2		39.4		31.4			50.2
1/2	KKA6P-03M-1	R3/8	22	37.9	20.4	31.4	11.0	76.0	41.9
	-04M-1	R1/2		40.9		32.9			56.0
	-06M-1	R3/4		30		42.9			33.4

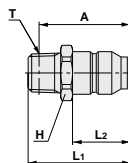

内螺纹式

(mm)



接头体尺寸	型号	T 接管口径	H 六角对边	L1	L2	最小孔径	有效截面积 mm ²	质量 g
1/8	KKA3P-01F-1	Rc1/8	14	23.2	16.0	6.0	22.6	9.6
	-02F-1	Rc1/4	17	30.3				20.2
	-03F-1	Rc3/8	19	32.0				26.2
1/4	KKA4P-02F-1	Rc1/4	19	29.7	18.9	8.0	40.2	20.0
	-03F-1	Rc3/8		34.0				25.8
	-04F-1	Rc1/2		39.4				46.1
1/2	KKA6P-03F-1	Rc3/8	24	30.9	20.4	11.0	76.0	34.3
	-04F-1	Rc1/2		39.6				50.0
	-06F-1	Rc3/4		42.8				78.6

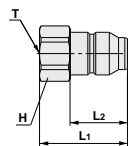

外形尺寸图 / 插座(S)

无单向阀

外螺纹式

(mm)



接头体尺寸	型号	T 接管口径	H 六角对边	øD	L	A	最小孔径	有效截面积 mm ²	质量 g
1/8	KKA3S-01M-1	R1/8	17	18.5	38.1	34.1	6.1	23.4	36.1
	-02M-1	R1/4			41.1	35.1			39.4
	-03M-1	R3/8			42.1	35.6			43.9
1/4	KKA4S-02M-1	R1/4	22	24.2	46.0	40.0	8.1	41.2	71.9
	-03M-1	R3/8			47.0	40.5			73.6
	-04M-1	R1/2			50.0	42.0			81.7
1/2	KKA6S-03M-1	R3/8	30	30.7	51.4	44.9	11.4	81.6	138.3
	-04M-1	R1/2			54.4	46.4			149.6
	-06M-1	R3/4			56.4	46.9			174.0

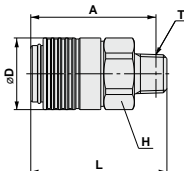

内螺纹式

(mm)



接头体尺寸	型号	T 接管口径	H 六角对边	øD	L	最小孔径	有效截面积 mm ²	质量 g
1/8	KKA3S-01F-1	Rc1/8	19	18.5	37.6	6.1	23.4	44.5
	-02F-1	Rc1/4			41.2			44.8
	-03F-1	Rc3/8			43.1			49.9
1/4	KKA4S-02F-1	Rc1/4	22	24.2	46.1	8.1	41.2	92.2
	-03F-1	Rc3/8			46.9			86.2
	-04F-1	Rc1/2			52.3			99.4
1/2	KKA6S-03F-1	Rc3/8	30	30.7	50.5	11.4	81.6	178.8
	-04F-1	Rc1/2			56.2			191.2
	-06F-1	Rc3/4			57.9			169.8

