

带快换接头的速度控制阀 不锈钢系列 弯头型 / 万向型 AS-FG 系列



耐腐蚀环境下可使用的不锈钢规格
金属材料部采用SUS303

适用于不允许有铜离子的CRT线、遇到水及盐水的食品装置的水洗净、防止铜材变色或生锈而出现尘埃的清洁室内。

装置上匹配明亮的颜色

阀体、释放套采用白色的树脂

螺纹部带密封剂、不带密封剂都已标准化

适合管子：英制尺寸已标准化

全部品种都有英制尺寸。



弯头型



万向型

型号

弯头型	万向型	接管 口径	适合管子外径(mm)																			
			米制						英制													
			3.2	4	6	8	10	12	1/8"	3/16"	1/4"	5/16"	3/8"	1/2"								
AS12□1FG-M5	AS13□1FG-M5	M5x0.8	●	●	●																	
AS22□1FG-01	AS23□1FG-01	R1/8	●	●	●	●	●	●														
AS22□1FG-02	AS23□1FG-02	R1/4		●	●	●	●	●														
AS32□1FG-02	AS33□1FG-02	R1/4			●	●	●	●														
AS32□1FG-03	AS33□1FG-03	R3/8			●	●	●	●														
AS42□1FG-04	AS43□1FG-04	R1/2					●	●														
AS12□1FG-U10/32	AS13□1FG-U10/32	10-32UNF								●	●	●	●									
AS22□1FG-N01	AS23□1FG-N01	NPT1/8								●	●	●	●									
AS22□1FG-N02	AS23□1FG-N02	NPT1/4									●	●	●	●								
AS32□1FG-N02	AS33□1FG-N02	NPT1/4										●	●	●	●							
AS32□1FG-N03	AS33□1FG-N03	NPT3/8											●	●	●	●						
AS42□1FG-N04	AS43□1FG-N04	NPT1/2																		●	●	●

注1) 排气节流、进气节流的外观识别用树脂阀体上的流动方向记号来识别。

注2) ※仅有弯头型。

规格

使用流体	空气
保证耐压力	1.5MPa
最高使用压力	1MPa
最低使用压力	0.1MPa
环境温度及使用流体温度	-5~60°C(未冻结时)
注) 适合管材质	尼龙、软尼龙、聚氨酯

注) 注意软尼龙、聚氨酯的最高使用压力。
(详见P.411, 412。)

流量及声速流导

JIS图形符号

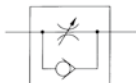

阀体上表示的流动方向记号

记号	排气节流式	进气节流式
JIS符号		

型号	AS12□1FG	AS22□1FG-□01	AS22□1FG-□02	AS32□1FG	AS42□1FG							
	AS13□1FG	AS23□1FG-□01	AS23□1FG-□02	AS33□1FG	AS43□1FG							
管子 外径	米制尺寸	ø3.2 ø4 ø6	ø3.2 ø4 ø8 ø10	ø4 ø6 ø8 ø10	ø6 ø8 ø10 ø12	ø10 ø12						
	英制尺寸	ø1/8" ø5/32" ø3/16"	ø1/8" ø5/32" ø1/4" ø5/16"	ø3/16" ø1/4" ø5/16" ø3/8"	ø1/4" ø5/16" ø3/8"	ø3/8" ø1/2"						
控制流向 自由流向	流量 L/min(ANR)	100	180	230	260	390	460	660	790	920	1580	1710
	声速流导 dm³/(s·bar)	0.28	0.50	0.64	0.72	1.1	1.3	1.8	2.2	2.6	4.4	4.8
临界 压力比	控制流向	0.2	0.25	0.3		0.25		0.25		0.25		0.25
	自由流向	0.4	0.2	0.3		0.2		0.2		0.3		0.3

注) 流量是压力为0.5MPa、温度20°C时的值。



订制规格
(详见P.543。)

型号表示方法

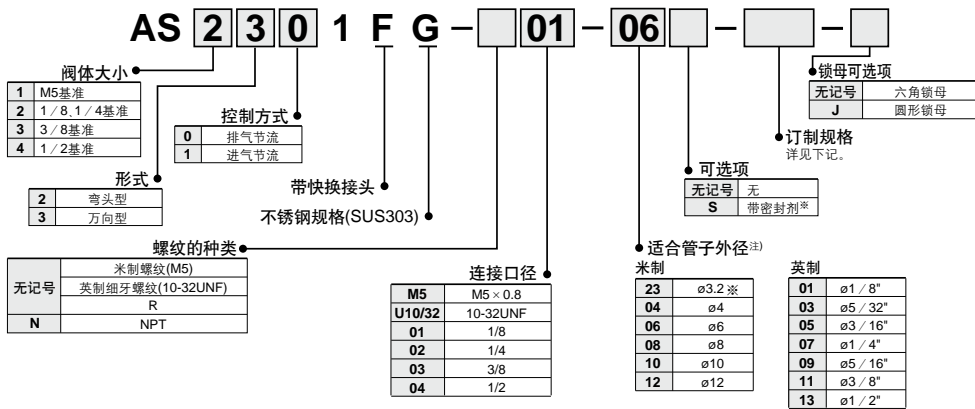

定制规格

注) 适合管子外径的选定请由P.542形式表确定。
※ 请使用φ1/8的管子。



1 润滑剂: 凡士林

X12

(例) AS1201FG-M5-23-X12

2 无润滑脂(密封材料氟涂层) + 节流阀(无单向阀)

X21

(例) AS1201FG-M5-23-X21

注1) 不是无发尘。
注2) 节流阀仅排气节流的型号对应。

3 节流阀(无单向阀)

X214

(例) AS1201FG-M5-23-X214

注) 节流阀仅排气节流的型号对应。

针阀 / 流量特性

注) 流量特性为代表作。

AS12□1FG
AS13□1FG

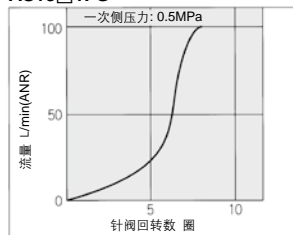

AS22□1FG-□01
AS23□1FG-□01

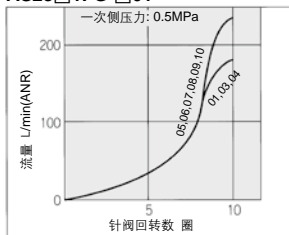

AS22□1FG-□02
AS23□1FG-□02

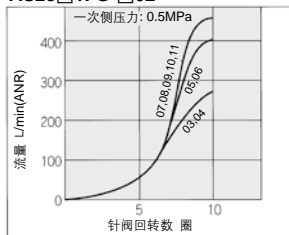

AS32□1FG
AS33□1FG

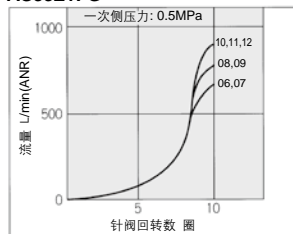

AS42□1FG
AS43□1FG

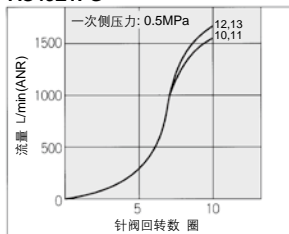

AS-FG 系列

结构图/弯头型

排气节流式

M5式

U10 / 32式

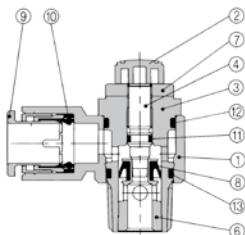
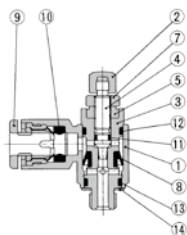

AS3201FG-02

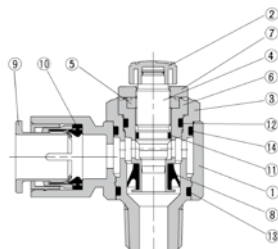

进气节流式

M5式

U10 / 32式

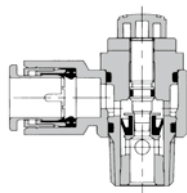
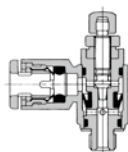

AS3211FG-02

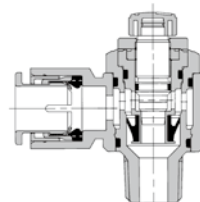

构成零件

件号	零部件名	材质	
1	阀体A	PBT	
2	手轮	PBT	
3	阀体B	SUS303	
4	针阀	SUS303	
5	针阀导座	SUS303	
6	护环	SUS303	
7	锁母	SUS303	
8	U形密封圈	HNBR	
9	释放套	—	
10	密封圈	NBR	
11	O形圈	NBR	
12	O形圈	NBR	
13	O形圈	NBR	
14	O形圈	NBR	
15	密封垫	NBR/不锈钢	仅M5式

△ 注意

使用前必读。
 安全上的注意参见前附56、驱动控制元件 / 共同注意事项由P.468~471确认。

结构图 / 万向型

排气节流式
M5式
U10 / 32式

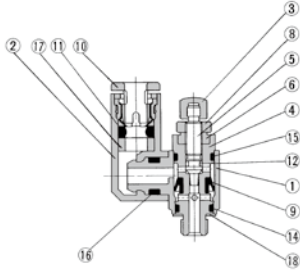

AS3301FG-02

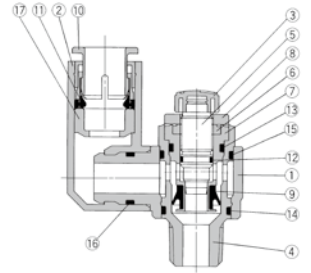
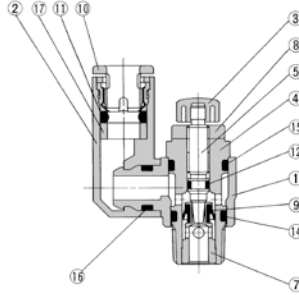

进气节流式
M5的场合
U10 / 32的场合

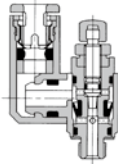

AS3311FG-02

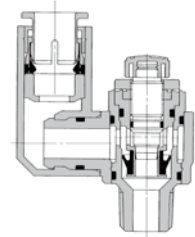
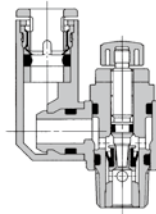

构成零部件

件号	零部件名	材质	备注
1	阀体A	PBT	
2	弯头阀体	PBT	
3	手轮	PBT	
4	阀体B	SUS303	
5	针阀	SUS303	
6	针阀导座	SUS303	
7	护环	SUS303	
8	锁母	SUS303	
9	U形密封圈	HNBR	
10	释放套	-	
11	密封圈	NBR	
12	O形圈	NBR	
13	O形圈	NBR	
14	O形圈	NBR	
15	O形圈	NBR	
16	O形圈	NBR	
17	衬套	-	
18	密封垫	NBR · 不锈钢	仅M5型

AS
TMH
ASD
AS
AS-FE KE
AS-FG
AS-FP
AS-FM
AS-D AS-T
ASP
ASN
AQ
ASV
AK
VCHC
ASS
ASR ASQ

AS-FG 系列

外形尺寸图/弯头型

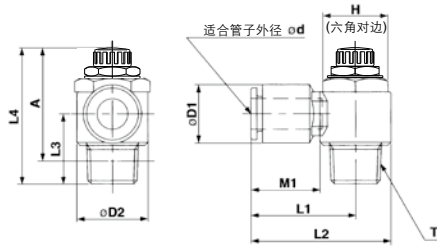

M5の場合
U10/32の場合

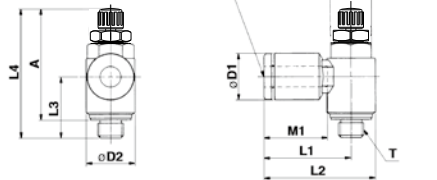

米制

型号	d	T	H	D1	D2	L1	L2	L3	注1) L4		注2) A		M1	质量 g
									MAX	MIN	MAX	MIN		
AS12□1FG-M5-23	3.2	M5×0.8	8	8.4	9.6	17.3	22.1	12.3	28.6	25.8	25	22.2	12.7	7
AS12□1FG-M5-04	4	M5×0.8	8	9.3	9.6	17.3	22.1	12.3	28.6	25.8	25	22.2	12.7	7
AS12□1FG-M5-06	6	M5×0.8	8	11.6	9.6	18.1	22.9	11.7	28.6	25.8	25	22.2	13.5	7
AS22□1FG-01-23	3.2	R1/8	12	9.3	14.2	20.4	27.5	14.3	36.1	31.1	32.1	27.1	12.7	16
AS22□1FG-01-04	4			9.3		20.4	27.5		12.7				12.7	17
AS22□1FG-01-06	6			11.6		20.4	27.5	13.4	35.2	30.2	32.1	27.1	13.5	19
AS22□1FG-01-08	8			15.2	14.2	25.3	32.4		18.5				18.5	19
AS22□1FG-01-10	10			18.5		32.1	39.2	14.1					21	21
AS22□1FG-02-04	4			10.4		25.2	34.4		16				16	32
AS22□1FG-02-06	6			12.8	18.5	25.2	34.4	17.7	17				17	34
AS22□1FG-02-08	8			15.2		27.2	36.4		18.5	34.9	34.4	29.4	18.5	34
AS22□1FG-02-10	10			18.5		35.3	44.5	18.3	21				21	36
AS32□1FG-02-06	6			12.8		27.8	39.3		17				17	60
AS32□1FG-02-08	8			15.2		29.5	41		18.5				18.5	63
AS32□1FG-02-10	10			18.5	23	31.8	43.3		21	48.3	43.3	37.8	21	67
AS32□1FG-02-12	12			20.9		32.8	44.3		22				22	69
AS32□1FG-03-06	6			12.8		27.8	39.3		17				17	55
AS32□1FG-03-08	8			15.2		29.5	41		18.5				18.5	57
AS32□1FG-03-10	10			18.5		31.8	43.3	19.8	21	45.4	40.4	40.2	21	59
AS32□1FG-03-12	12			20.9		32.8	44.3		22				22	61
AS42□1FG-04-10	10			18.5		33.6	47.9		21				21	100
AS42□1FG-04-12	12	R1/2	24	21.7	28.6	35.2	49.5	24.5	25.6	56.7	49.2	49.6	22	101

注1) 参考尺寸

注2) M5 × 0.8, R螺纹拧入后的参考尺寸

英制

型号	d	T	H	D1	D2	L1	L2	L3	注1) L4		注2) A		M1	质量 g
									MAX	MIN	MAX	MIN		
AS12□1FG-U10/32-01	1/8"			8.4		17.3	22.1	12.3					12.7	7
AS12□1FG-U10/32-03	5/32"			9.3	9.6	17.3	22.1	12.3					12.7	
AS12□1FG-U10/32-05	3/16"	10-32UNF	8	11.4		21.3	26.1	11.7	28.6	25.8	25	22.2	16.5	
AS12□1FG-U10/32-07	1/4"			12		18.3	23.1						13.5	
AS22□1FG-N01-01	1/8"			9.3		20.4	27.5						12.7	16
AS22□1FG-N01-03	5/32"			11.4		23.1	30.2	13.4	35.2	30.2	32.1	27.1	12.7	17
AS22□1FG-N01-05	3/16"	NPT 1/8	12.7	11.4	14.2	23.1	30.2						17	19
AS22□1FG-N01-07	1/4"			13.2		23.9	31						17	19
AS22□1FG-N01-09	5/16"			15.2		25.3	32.4	14.1					18.5	21
AS22□1FG-N02-03	5/32"			10.4		25.2	34.4						16	32
AS22□1FG-N02-05	3/16"			11.4		24.9	34.2	17.7					16.5	
AS22□1FG-N02-07	1/4"	NPT 1/4	17.5	13.2	18.5	25.2	34.5		39.9	34.9	34.4	29.4	17	34
AS22□1FG-N02-09	5/16"			15.2		27.2	36.4	18.2					18.5	36
AS22□1FG-N02-11	3/8"			17.9		35.3	44.5	18.8					21	
AS32□1FG-N02-07	1/4"			13.2		27.8	39.3						17	60
AS32□1FG-N02-09	5/16"	NPT 1/4	19	15.2	23	29.5	41	21.3	48.3	43.3	42.8	37.8	18.5	63
AS32□1FG-N02-11	3/8"			17.9		31.8	43.3						21	67
AS32□1FG-N03-07	1/4"			13.2		27.8	39.3						17	55
AS32□1FG-N03-09	5/16"	NPT 3/8	19	15.2	23	29.5	41	19.8	45.4	40.4	40.2	35.2	18.5	57
AS32□1FG-N03-11	3/8"			17.9		31.8	43.3						21	59
AS42□1FG-N04-11	3/8"	NPT 1/2	23.8	17.9	28.6	33.6	47.9		24.5	56.7	49.2	49.6	21	100
AS42□1FG-N04-13	1/2"			21.7		35.2	49.5						22	101

注1) 参考尺寸

注2) 10-32UNF, NPT螺纹的螺纹拧入后的参考尺寸

外形尺寸图 / 万向型

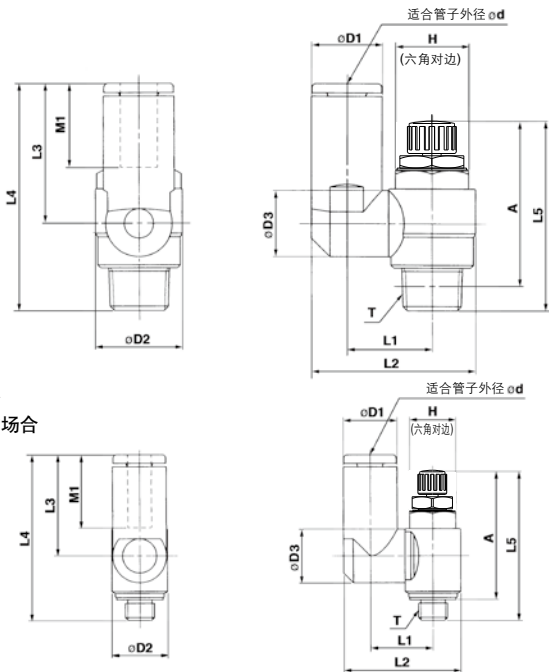

M5の場合
U10/32の場合

米制

型号	d	T	H	D1	D2	D3	L1	L2	L3	L4	注1) L5		注2) A		M1	质量 g
											MAX.	MIN.	MAX.	MIN.		
AS13□1FG-M5-23	3.2		8.4		8.4	9.6	9.3	10.8	20.3	17.5	28.7	28.6	25	22.2	12.7	7
AS13□1FG-M5-04	4	M5x0.8	9.3		9.3	10.8	20.3	21.4	20.6	31.8					13.5	17
AS13□1FG-M5-06	6		11.6		11.6			21.4	20.6	31.8					18.5	21
AS23□1FG-01-23	3.2		8.4		8.4	9.3	13.1	24.4	17.5	30.9	35.2	30.2	32.1	27.1	12.7	17
AS23□1FG-01-04	4		9.3		9.3	10.9	14.2	26.9	23.9	36.3					13.5	18
AS23□1FG-01-06	6		11.6		11.6	12.9	16.2	30.9	28.2	40.8					18.5	21
AS23□1FG-01-08	8		15.2		15.2	10.9	16.2	30.9	28.2	40.8					16	32
AS23□1FG-02-04	4		10.4		10.4	10.9	16.2	30.9	21.9	38.6					17	33
AS23□1FG-02-06	6		12.8		12.8	18.4	34	25.2	42.1		39.9	34.9	34.4	29.4	18.5	36
AS23□1FG-02-08	8		15.2		15.2	18.3	35.2	28.2	45.1						21	40
AS23□1FG-02-10	10		18.5		18.5	20.2	38.7	31	47.9						17	60
AS33□1FG-02-06	6		12.8		12.8	20.6	38.5	25.2	46.5		48.3	43.3	42.8	37.8	18.5	63
AS33□1FG-02-08	8		15.2		15.2	20.6	38.7	28.2	49.5						21	67
AS33□1FG-02-10	10		18.5		18.5	23	43.7	32.6	53.9						22	69
AS33□1FG-02-12	12		20.9		20.9			44.9	34.4	55.7					17	56
AS33□1FG-03-06	6		12.8		12.8	12.9	20.6	38.5	25.2	45					18.5	59
AS33□1FG-03-08	8		15.2		15.2	20.9	20.6	38.7	28.2	48					21	63
AS33□1FG-03-10	10		18.5		18.5	23	23	43.7	32.6	52.4					22	65
AS33□1FG-03-12	12		20.9		20.9			44.9	34.4	54.2					21	63
AS43□1FG-04-10	10		18.5		18.5	26.2	38.8	49.4	32.6	57.1					21	104
AS43□1FG-04-12	12		21.7		21.7	28.6	39.4	42.6	36.3	60.8					22	105

注1) 参考尺寸

注2) M5 × 0.8、R螺纹的螺纹拧入后的参考尺寸

英制

型号	d	T	H	D1	D2	D3	L1	L2	L3	L4	注1) L5		注2) A		M1	质量 g
											MAX.	MIN.	MAX.	MIN.		
AS13□1FG-U1032-01	1/8"		8.4		8.4	9.6	9.3	10.8	20.3	17.5	28.7	28.6	25	22.2	12.7	7
AS13□1FG-U1032-03	3/32"		9.3		9.3	10.8	20.3	21.4	20.6	31.8					13.5	17
AS13□1FG-U1032-05	5/32"		11.4		11.4			21.4	20.6	31.8					18.5	21
AS13□1FG-U1032-07	7/32"		13.2		13.2			21.4	20.6	31.8					17	33
AS23□1FG-N01-01	1/8"		8.4		8.4	9.3	13.1	24.4	17.5	30.9	35.2	30.2	32.1	27.1	12.7	17
AS23□1FG-N01-03	3/32"		9.3		9.3	10.9	14.2	26.9	23.9	36.3					13.5	18
AS23□1FG-N01-05	5/32"		11.4		11.4	12.9	16.2	30.9	28.2	40.8					18.5	21
AS23□1FG-N01-07	7/32"		13.2		13.2	10.9	16.2	30.9	28.2	40.8					16	32
AS23□1FG-N01-09	9/32"		15.2		15.2	10.9	16.2	30.9	28.2	40.8					17	33
AS23□1FG-N02-03	3/32"		11.4		11.4	10.9	16.2	30.6	21.9	39.6					17	33
AS23□1FG-N02-05	5/32"		13.2		13.2	16.3	18.3	31.1	23.9	42.1					21	40
AS23□1FG-N02-07	7/32"		15.2		15.2	20.2	38.7	31	47.9						17	60
AS23□1FG-N02-11	3/8"		17.9		17.9			35.2	28.2	47.9					21	39
AS23□1FG-N02-11	3/8"		17.9		17.9			35.2	28.2	47.9					21	39
AS33□1FG-N02-07	7/32"		13.2		13.2	12.9	20.6	38.7	25.8	46.9					17	60
AS33□1FG-N02-09	9/32"		15.2		15.2	12.9	20.6	39.7	28.2	49.5					18.5	63
AS33□1FG-N02-11	3/8"		17.9		17.9	16.2	23	43.7	32.6	53.9					21	69
AS33□1FG-N03-07	7/32"		13.2		13.2	12.9	20.6	38.7	25.8	45					17	56
AS33□1FG-N03-09	9/32"		15.2		15.2	12.9	20.6	39.7	28.2	48					21	59
AS33□1FG-N03-11	3/8"		17.9		17.9	16.2	23	43.7	32.6	52.4					21	65
AS43□1FG-N04-11	3/8"		17.9		17.9	16.2	25.8	49.4	32.6	54.4					21	104
AS43□1FG-N04-13	1/2"		21.7		21.7	18.4	28.6	52	36.3	57.1					22	106

注1) 参考尺寸

注2) 10-32UNF、NPT螺纹的螺纹拧入后的参考尺寸